

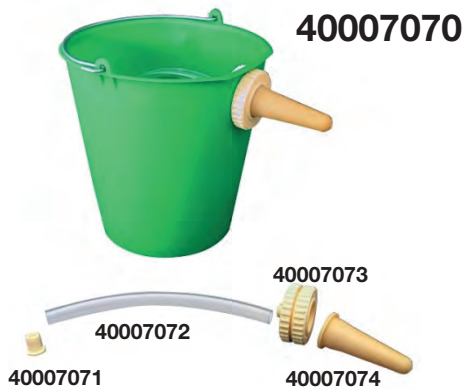

## LIVESTOCK - Zootecnia



## LIVESTOCK - ZOOTECNIA



40007070	<b>COMPLETE CALF FEEDING BUCKET LT. 12</b> Secchio poppatoio completo lt. 12
40007071	<b>VALVE - Valvola</b>
40007072	<b>TUBE 16X20 -LENGTH 33</b> Tubo 16x20 -lungh. 33
40007073	<b>RING NUT - Ghiera</b>
40007074	<b>TEAT - Tettarella grande</b>
40007075	<b>BUCKET - Secchio</b>



**40001000**  
**CALF -DRINKING PAIL, PLASTIC WITH TEAT, VALVE AND BACK HOLDER**  
 Secchio in plastica per abbeveraggio vitelli con poppatoio, valvola e gancio posteriore

**40001010**  
**AS 40001000 WITH LID**  
 Come il 40001000 con coperchio



**40001020**  
**CALF DRINKING PAIL PLASTIC WITH TEAT ON THE TOP, WITH VALVE, TUBE, NON RETURN VALVE, TEAT AND BACK HOLDER**

Secchio in plastica per abbeveraggio vitelli con poppatoio superiore, valvola, tubo, valvola antirisucchio e gancio posteriore



**40001019**  
**LAMB DRINKING PAIL PLASTIC WITH TEAT ON THE TOP, WITH VALVE, TUBE, NON RETURN VALVE, TEAT AND BACK HOLDER**  
 Secchio in plastica per abbeveraggio agnelli con poppatoio sup., valvola, tubo, valvola antirisucchio e gancio posteriore



**40001070**  
**LAMB-BAR 3 FEEDER COMP. WITH VALVE, TEAT AND BACK HOLDER**  
 Secchio in plastica per abbeveraggio agnelli con 3 poppatoi, con valvola e gancio posteriore



**40001080**  
**LAMB-BAR 5 FEEDER COMP. WITH VALVE, TEAT AND BACK HOLDER**  
 Secchio in plastica per abbeveraggio agnelli con 5 poppatoi, con valvola e gancio posteriore



**40001040**  
**CALF DRINKING PAIL ROUND 12 L WITH FEEDING ON THE TOP, WITH VALVE, TUBE, NON-RETURN VALVE AND TEAT**  
 Secchio tondo da 12 lt. con poppatoio sulla parte superiore, con valvola, tubo, valvola antirisucchio



**40001130**  
**LAMB-BAR, 6 FEEDER DOUBLE FLAT, WITH SMALL TEAT, VALVE AND BACK HOLDER**  
 Secchio in plastica per abbeveraggio agnelli con 6 piccoli poppatoi, valvola e gancio posteriore



**40001090**  
**LAMB-BAR 10 L WITH 6 TEATS AND VALVE**  
 Secchio in plastica per abbeveraggio agnelli da lt. 10 con 6 poppatoi e valvola



**40001120**  
**LAMB-BAR 10 L 6 FEEDER WITH SMALL TEATS AND VALVE**

Secchio in plastica per abbeveraggio agnelli da 10 lt. con 6 poppatoi piccoli e valvola



**40001170**  
**COVER LID FOR 40001060 -40001070 - 40001080**

Coperchio superiore per articoli 40001060 -40001070 - 40001080



**40002000**  
**VALVE SAVE FOR OVERSTRIP**  
Valvola di sicurezza



**40001200**  
**BACK HOLDER METAL**  
Supporto in metallo



**40003230**  
**LOWER CHECK VALVE**  
Valvola di controllo inferiore



**40001190**  
**BACK HOLDER PLASTIC**  
Supporto in plastica resistente



**40002010**  
**WASHER FOR VALVE**  
Guarnizione per valvola



**40002040**  
**VALVE FOR LAMB-BAR 40001120-40001130**  
Valvola per secchio per agnelli 40001120/1130



**40004100**  
**MILK BOTTLE 500 ML WITH SCALE AND WITH A VERY SOFT TEAT FOR SMALL ANIMALS**  
Bottiglia in plastica graduata da 500 ml. con poppatoio molto morbido per piccoli animali



**40004110**  
**MILK BOTTLE 1 L WITH SCALE AND TEAT FOR CALVES**  
Bottiglia in plastica graduata da 1 lt. con poppatoio per vitelli

**40004101**  
**MILK BOTTLE 500 ML FOR CALVES**  
Bottiglia in plastica graduata da 500 ml per vitelli

**40004120**  
**MILK BOTTLE 1 L WITH SCALE AND LAMB-TEAT**  
Bottiglia in plastica graduata da 1 lt. con poppatoio per agnelli



**40004130**  
**MILK BOTTLE 2 L WITH SCALE AND TEAT FOR CALVES**  
Bottiglia in plastica graduata da 2 lt. con poppatoio per vitelli



**40004144**  
**MILK BOTTLE 3 L WITH SCALE, VALVE, BIG OPENING AND LAMB-TEAT**  
Bottiglia in plastica graduata da 3 lt., con valvola, bocca grande e poppatoio per agnelli

**40004140**  
**MILK BOTTLE 2 L WITH SCALE AND LAMB-TEAT**  
Bottiglia in plastica graduata da 2 lt. con poppatoio per agnelli

**40004145**  
**MILK BOTTLE 3 L WITH SCALE, VALVE, BIG OPENING AND TEAT FOR CALVES**  
Bottiglia in plastica graduata da 3 lt., con valvola, bocca grande e poppatoio per vitelli



**40009999**

**ORIGINAL "HIKO" CALF TEAT 10 CM, 4 MM HOLE, SUITABLE FOR DL AND FÖRSTER AUTOMATIC FEEDER**

Poppatoio originale "HIKO" 10 cm, for 4 mm, ideale per allattatrici DL e FÖRSTER



**40003120**  
**CALF TEAT**  
**BLACK CYL. 100**  
**MM, SPECIAL**  
**QUALITY**

Poppatoio nero per vitelli cyl da 100 mm, di qualità speciale



**40003130**  
**CALF TEAT**  
**GREEN CYL. 100**  
**MM TOP QUALITY**

Poppatoio verde per vitelli cyl. da 100 mm di altissima qualità



**40003172**  
**CALF TEAT,**  
**NATURAL**  
**CAOUTCHOUC**  
**100 MM. VERY**  
**SOFT**

Poppatoio in lattice naturale da 100 mm. Molto soffice



**40003000**  
**CALF-TEAT**  
**SHORT ZYL. 100**  
**MM**

Poppatoio corto per vitelli da 100 mm



**40003010**  
**CALF-TEAT LONG**  
**ZYL. 120 MM**

Poppatoio lungo x vitelli da 120 mm



**40003020**  
**CALF-TEAT**  
**SHORT CONICAL**  
**100 MM**

Poppatoio per vitelli conico corto da 100 mm



**40003040**  
**TEAT RED FOR ALU AND**  
**FLOATING VALVE**

Poppatoio rosso per valvola a galleggiante e alluminio



**40003066**  
**LAMB TEAT WHITE**  
**FOR LAMB-BAR**

poppatoio bianco agnelli per secchio)  
 40001060  
 40001070 - 40001080  
 40001090 - 40001100



**40003080**  
**LAMB-TEAT RED FOR**  
**VALVE 40002040 AND**  
**LAMB-BAR 40001130-**  
**40001120**

Poppatoio per agnelli rosso per valvola 40002040 e secchio 40001120/1130



**40003060**  
**LAMB-TEAT RED FOR VALVE**  
**40002000 AND LAMB-BAR**  
**40001060/1070/1080/1090/1100**

Poppatoio rosso per agnelli x valvola 40002000 e x secchio 40001060/1070/1080/1090/1100



**40003101**  
**CALF TEAT WHITE**  
**CYL. 100 MM**

Poppatoio bianco per vitelli cyl. da 100 mm



**40003100**  
**CALF TEAT WHITE**  
**CON. 100 MM**

Poppatoio bianco per vitelli con. da 100 mm



**40003160**  
**LAMB TEAT, LATEX**  
**(PARTICULARLY**  
**INDICATED FOR DL/**  
**FORSTER CALFRIL)**

Poppatoio in lattice per agnelli (ideali per allattatrici DL/Forster)



## TEATS WITH HOLE IN NATURAL LATEX, ITALIAN PRODUCTION POPPATOI CON FORO IN LATTICE NATURALE DI PRODUZIONE ITALIANA



**40007000**  
**TEAT."BOCCIOLIO" MODEL**

Tettaruolo mod. Boccioło



**40007001**  
**TEAT FOR CALVES "FLOATING" MODEL**

Tettaruolo per vitelli modello poppatoio galleggiante



**40007002**  
**CONICAL TEAT MM. 100**

Tettaruolo mod. conico mm. 100



**40007003**  
**CONICAL TEAT MM. 130**

Tettaruolo mod. conico mm. 130



**40007004**  
**CONICAL TEAT MM. 150**

Tettaruolo mod. conico mm. 150



**40007005**  
**TEAT FOR CALVES "LANCIA" MODEL**

Tettaruolo per vitelli modello lancia



**40007006**  
**TEAT FOR LAMBS**

Tettaruolo per agnelli



**40007007**  
**CYLINDRICAL TEAT FOR COWS MM 100**

Poppatoio cilindrico per bovini mm 100



**40007008**  
**CYLINDRICAL TEAT FOR COWS MM 125**

Poppatoio cilindrico per bovini mm 125



**40007009**  
**TEAT FOR LAMBS "BOTTLE" MODEL**

Poppatoio per agnelli mod. Bottiglia



**40007010**  
**TEAT FOR LAMBS -"BIBERON PAIL" MODEL**

Poppatoio per agnelli mod. Secchio-Biberon



**40008050**  
**COW IMMOBILIZER, GALVANIZED**

FERMA CALCI , galvanizzato



**40008060**  
**TAIL CLAMP FOR COWS , GALVANIZED**

FERMACODA PER BOVINI, zincato



**40008070**  
**CALF WEANER PLASTIC**

Antisucchio



**40008071**  
**CALF WEANER PLASTIC (LIGHT TYPE)**

Antisucchio mod. Leggero

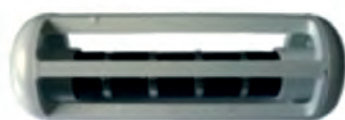

**40009000**  
**RUMINAL MAGNET PERMANENT POWER**

Calamita per ruminanti a potenza permanente L. 10,5 Cm



**40009010**  
**RUMINAL MAGNET**

Calamita per ruminanti L. 10 Cm



**4000PT01**  
**FEEDER BOTTLE WITH HANDLE 2 LT**

Bottiglia alimentazione con manico, lt. 2



**4000PT02**  
**CALF FEEDER 5 STATIONS, MAX 30 LT**

Alimentatore 5 posti, max 30 lt



**4000PT03**  
**PEACH TEAT PINK WITH THREAD**

Poppatoio rosa con filetto



**4000PT04**  
**PEACH TEAT BLACK WITH THREAD**

Poppatoio nero con filetto



**4000PT05**  
**PULL-THROUGH PEACH TEAT BLACK**

Poppatoio innesto a pressione nero



**4000PT08**  
**FEEDING BUCKET, BLACK**  
Secchio alimentazione nero



**40007020**  
**MERRICK'S BOTTLE, WITH PATENTED AIR RELEASE VALVE**  
Bottiglia Merrick's con valvola di rilascio dell'aria brevettata

## MARKING NECK STRAP - COLLARE IDENTIFICAZIONE VACCHE



**00111878**  
**WIDTH. 40 MM**  
**LENGTH. 135 CM**  
 Largh. 40 MM  
 Lungh. 135 cm



**00111866**  
**WIDTH. 40 MM**  
**LENGTH. 135 CM**  
 Largh. 40 MM  
 Lungh. 135 cm



**00111869**  
**WIDTH. 40 MM**  
**LENGTH. 135 CM**  
 Largh. 40 MM  
 Lungh. 135 cm



**00111087**  
**WIDTH. 40 MM**  
**LENGTH. 135 CM**  
 Largh. 40 MM  
 Lungh. 130 cm



**00100878**  
**MARKING NECK STRAP**  
 Collare identificazione vacche



**00401977**  
**OVAL BUCKLE WELDED**  
**40X6 MM**  
 Maglia ovale 40x6 mm



**00401978**  
**D-RING WELDED**  
**40X6 MM**  
 Anello a D 40x6 mm



**00401979**  
**ROLL BUCKLE**  
**40 MM**  
 Fibbia 40 mm

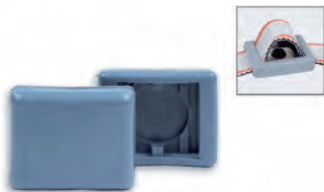

**00708700**  
**TRANSPONDER HOLDER**  
**40 MM (Ø 30 X 10 MM)**  
 Supporto per transponder  
 40 MM (Ø 30 X 10 MM)



**00708800**  
**TRANSPONDER REPAIR KIT**  
**(FOR DL 906500-80, 906501-80)**  
 Kit riparazione transponder (per  
 DL 906500-80, 906501-80)



**00708900**  
**SHACKLE ADJUSTABLE (WITH**  
**REINFORCED LEATHER PARTS)**  
 Cinghia anti zoppicamento  
 (con rinforzi in pelle)



**00709000**  
**SHACKLE**  
 Cinghia anti zoppicamento



**00709200**  
**ANKLE WEBBING**  
**FOR TRANSPONDER**  
**40 MM (HOLLOW)**  
 Cinghia  
 per transponder  
 da caviglia (cava)



**00709300**  
**ANKLE WEBBING**  
**WITHOUT BUCKLE,**  
**FITTING AFIMILK**  
 Stringa  
 per caviglia senza  
 fibbia, tipo AFIMILK



**00709100**  
**SHACKLE**  
**ADJUSTABLE**  
 Cinghia  
 anti zoppicamento  
 regolabile



**MARKING NUMBERS (10 PCS/PACK)**  
**normally sold in orange color**  
 Numeri per collare (conf. da 10 pz) normalmente  
 consegnato in colore arancione

#1	00100879-1
#2	00100879-2
#3	00100879-3
#4	00100879-4
#5	00100879-5
#6/9	00100879-6
#7	00100879-7
#8	00100879-8
#0	00100879-0





**4086133**

**STRAP FOR AFITAG II PODOMETER,  
 GENUINE AFIMILK**

Fascetta x podometro AFITAG II, originale AFIMILK



**00800516**

**COLLAR WITH MOULDED PLASTIC  
 BUCKLE, 40 MM**

Collare con fibbia in plastica, 40 mm



**00222777**

**RIVET REINFORCED**

Rivetto rinforzato



**00111333**

**ANKLE WEBBING WITH SINGLE BUCKLE 40 MM  
 (FITT. NEDAP)**

Stringa per caviglia con fibbia singola (tipo Nedap)



**00111555**

**ANKLE WEBBING WITH INOX BUCKLE**

Stringa per caviglia con fibbia  
 42 cm, AFIMILK Style



**00111999**

**NECKLACE FOR CALVES WITH  
 INTEGRATED WEIGHT**

Collare per vitelli con peso integrato



**00111444**

**WEIGHT FOR NECKLACE 60MM, KG 0,5**

Peso per collare 60mm, 0,5 kg



**39915542**

**COLLAR W/ S.S. SIMPLE BUCKLE 40 MM,  
 BLUE/BLACK, 1,5 MT**

Collare con passante semplice 40 mm, blu/nero, 1,5 mt



**39915827**

**MARKING NECK STRAP BLUE/BLACK, 150 CM**

Collare identificazione blu/nero 150 cm



**40005757**

**COLLAR CUTTER 500 MM**

Strumento per taglio collari, 500 mm



## SUSPENDED DIAL BALANCE - BILANCIA SOSPESA A QUADRANTE



**40008080**  
**25 KG, IN STEPS OF 100 G**  
25 Kg, con passo da 100 g

**40008081**  
**50 KG, IN STEPS OF 200 G**  
50 Kg, con passo da 200 g

**40008082**  
**100 KG, IN STEPS OF 500 G**  
100 Kg, con passo da 500 g

**40008083**  
**250 KG, IN STEPS OF 1 KG**  
250 Kg, con passo da 1 kg

**FOR QUICK AND ECONOMIC WEIGHT CONTROL. ROBUST PLEXIGLASS DIAL COVER AND DURABLE BODY. HOOKS INCLUDED.**

Per un controllo veloce ed economico del peso. Quadrante in robusto plexiglass, corpo durevole. Ganci inclusi.



**40005070**  
**LICK-STONE HOLDER**  
Portasale a parete quadrato



**40006012**  
**MILK THERMOMETER LENGTH 35 CM**  
Termometro per latte lunghezza 35 cm



**40006013**  
**MILK THERMOMETER 28 CM**  
Termometro per latte 28 cm



**40004605**  
**ROPE SISAL 1,80 MT**  
Corda in sisal, 1,80 mt

**40004606**  
**LEADING ROPE SISAL WITH NYLON 3,20 MT**  
Briglia in sisal con nylon, 3,20 mt

**40004607**  
**ROPE JUTE 2,40 MT**  
Corda in juta 2,40 mt



**40005566**  
**SLURRY PUSHER PLASTIC**  
Spingi liquame in plastica



**40005544**  
**SLURRY SCRAPER WITH HIGH QUALITY ALUMINIUM STICK 175 CM**  
Spingi liquame con bastone alluminio alta qualita' 175 cm



**40005880**  
**MILKING SLEEVE**  
Manicotto per mungitura



**40005800**  
**COW PUSHER**  
Spingivacche



**40005014**  
**HIKO CHECK VALVE 8 MM (FITT. FOERSTER)**  
Valvola controllo Hiko 8mm (per allattatrici Foerster)

## DRINKING BOWLS-Abbeveratoi



**00709400**  
**STAINLESS STEEL DRINKING BOWL (FITTING DL S22 90602883)**  
 Abbeveratoio in acciaio inox (tipo DL S22 90602883)

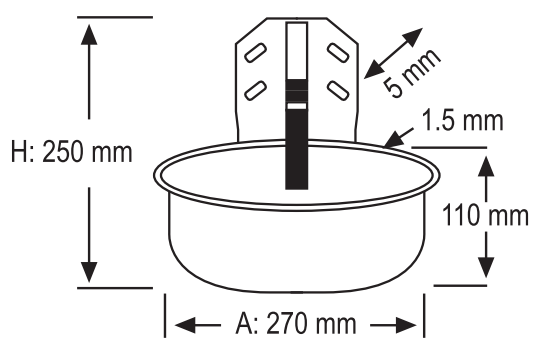

Codice	Descrizione	
<b>ABB_GH01</b>	<p><b>BOWL 1.5</b>                      Abbeveratoio in ghisa smaltata con valvola a pressione. Attacco acqua 1/2". Capacità 1,5 lt. Pressione d'esercizio da 0 a 3 atm. Fissaggio a parete.</p> <p><b>Enamelled cast-iron drinker with pressure valve. Water intake 1/2". Capacity 1,5 lt. Working pressure 0-3 atm. Wall mounting.</b></p>	
<b>ABB_GH02</b>	<p>Come sopra con fissaggio al tubo: 1", 1" 1/4, 1" 1/2</p> <p><b>Same as above with tube mounting: 1", 1" 1/4, 1" 1/2</b></p>	
<b>ABB_GH05</b>	<p><b>BOWL 2</b>                      Abbeveratoio in ghisa smaltata con valvola a pressione. Attacco acqua 1/2". Capacità 2 lt. Pressione d'esercizio da 0 a 5 atm. Fissaggio a parete.</p> <p><b>Enamelled cast-iron drinker with pressure valve. Water intake 1/2". Capacity 2 lt. Working pressure 0-5 atm. Wall mounting.</b></p>	
<b>ABB_GH06</b>	<p>Come sopra con fissaggio al tubo: 1", 1" 1/4, 1" 1/2</p> <p><b>Same as above with tube mounting: 1", 1" 1/4, 1" 1/2</b></p>	
<b>ABB_PL01</b>	<p><b>POOL 2</b>                      Abbeveratoio in plastica con valvola ad elevata portata. Attacco acqua 1/2". Capacità 5 lt. Pressione d'esercizio da 0 a 4 atm. Fissaggio a parete.</p> <p><b>Polypropylene drinker with high flow-rate valve. Water intake 1/2". Capacity 5 lt. Working pressure 0-4 atm. Wall mounting.</b></p>	
<b>ABB_PL02</b>	<p>Come sopra con fissaggio al tubo: 1", 1" 1/4, 1" 1/2</p> <p><b>Same as above with tube mounting: 1", 1" 1/4, 1" 1/2</b></p>	
<b>ABB_GH10</b>	<p><b>POOL-CAST</b>                      Abbeveratoio in ghisa smaltata con valvola ad elevata portata. Attacco acqua 1/2". Capacità 5 lt. Pressione d'esercizio da 0 a 4 atm. Fissaggio a parete.</p> <p><b>Enamelled cast-iron drinker with high flow-rate valve. Water intake 1/2". Capacity 5 lt. Working pressure 0-4 atm. Wall mounting.</b></p>	
<b>ABB_GH15</b>	<p>Come sopra con fissaggio al tubo: 1", 1" 1/4, 1" 1/2</p> <p><b>Same as above with tube mounting: 1", 1" 1/4, 1" 1/2</b></p>	



# LIVESTOCK - Zootecnia

## ABB\_VSR80

### VSR80

Vasca in plastica a doppia parete per una maggiore robustezza e minor rischio di formazione di ghiaccio.  
Tappo di scarico Ø80mm. Dotata di 1 galleggiante.  
Attacco acqua ¾". Pressione d'esercizio da 0 a 4 atm.  
Capacità 80 lt. Dimensioni: 115x34x41 cm

**Polyethylene drinking trough, extra-plastic wall to increase strongness and decrease the freezing risk. 80mm drain plug. Equipped with 1 float. Water intake ¾". Working pressure 0-4 atm. Capacity 80 lt. Dimensions: 115x34x41 cm**



## ABB\_ANT100

### NO-FROST

Abbeveratoio antigelo a livello costante con galleggiante ad elevata portata d'acqua.  
Pressione di esercizio da 0 a 4 atm.  
Capacità 100 lt. Dimensioni: 97x60x79(h) cm

**Antifreeze drinking trough with constant level and high flow-rate valve. Working pressure 0-4 atm. Capacity 100 lt. Dimensions: 97x60x79(h) cm**



## ABB\_LEV01

### PLASTIC BOWL

Abbeveratoio in plastica a livello costante con galleggiante e tappo di scarico sul fondo.  
Attacco acqua ½" dal basso.  
Pressione d'esercizio da 0 a 4 atm. Capacità 6 lt.  
Fissaggio a parete.

**Polypropylene constant level drinker, with float and drain plug. Water intake ½" from the bottom. Working pressure 0-4 atm. Capacity 6 lt. Wall mounting**



## ABB\_LEV02

Come sopra con fissaggio al tubo: 1", 1" ¼, 1" ½

Same as above with tube mounting: 1", 1" ¼, 1" ½

**SUITABLE FOR SHEEP AND GOATS**



### 00600007

#### PROTECTED FLOAT SUITABLE FOR VARIOUS TYPES OF TROUGHs

Galleggiante per diversi tipi di abbeveratoio



### 20070194

#### PLASTIC TROUGH

Abbeveratoio plastica



### RAIDEX LONG-LASTING MARKING STICK.

Marcatore di lunga durata per animali Raidex.

**40009020**

**RED** - Rosso

**40009021**

**GREEN** - Verde

**40009022**

**BROWN** - Marrone

**40009023**

**BLACK** - Nero



### 00300969

#### BOLUS

Bolo ruminale



### 00800421

#### MILK TAXI HOLM & LAUE KEYPAD

Tastiera per Milk Taxi Holm & Laue



## FLY TRAPS - TRAPPOLE PER MOSCHE



70603011	<b>FLYRIBBON HOLDER + 550M FLYRIBBON</b> 550 mt fly ribbon on a roll
70603312	<b>FLYRIBBON 550M REFILL</b> Nastro su rullo da 550 mt.
70603214	<b>FLYROLL 9 MT. - FLY ROLL WITH HANGER</b> Rullo con gancio (9x0,3 mt)
70603430	<b>FLYSTICK (10 STRIPS/PACK) - A SMALL GLUE TRAP TO BE USED INDOORS</b> Piccola trappola in colla da usare in interno. (10 strisce x conf.)
70603710	<b>FLYTUBE (12 SHEET/PACK) - TO BE FITTED AROUND PIPES OR CABLES (32X10 CM)</b> Da fissare intorno a tubazioni, cavi (32x10 cm) (12 fogli x conf.)
70603114	<b>FLYTRAP (6 SHEET/PACK) - LARGE SHEETS. (32X60 CM)</b> Fogli larghi. (32x60 cm) (6 fogli x conf.)

**ECOLOGICAL!**

**40005090**  
**CATTLE BRUSH, COMPLETE WITH IRON U-RAIL, STRONG SPRING**

Spazzole per bestiame, con guida ad U in ferro e molla resistente

**40005091**  
**BRUSH SPARE PART**  
 spazzola di ricambio



**40005095**  
**CATTLE BRUSH, PLASTIC WITH STRONG SPRING**

Spazzole per bestiame, in plastica, con molla resistente

**40005096**  
**BRUSH SPARE PART**  
 spazzola di ricambio



## SWINGING COW BRUSHES - SPAZZOLONI ROTANTI



**40006000**  
**AUTOMATIC SCRATCH BRUSH - Spazzola rotante automatica**

**BENEFITS:**

- Helps maintaining of the health and comfort of the cows.
- It removes parasites, dust, mud etc. and allows the skin to breathe.
- Improves the quality of the skin.
- Meat and milk production increases by 10%.
- The relationship between the cows is reduced and potential accidents and injuries are prevented.
- Helps cleaning areas outside the visual field of the animal

**BENEFICI**

- mantiene la salute e il comfort delle vacche
- rimuove parassiti, polvere, fango ecc. e permette alla pelle di respirare
- migliora le condizioni del manto
- migliora la produzione di latte e carne del 10%
- le relazioni tra i capi si riducono, riducendo a loro volta i potenziali incidenti
- aiuta la pulizia delle zone fuori dal campo visivo dell'animale.

**LENGTH MM 730**  
 Lunghezza mm 730

**Ø/MM 440**  
 Ø/mm 440

**BRISTLE**  
 Setola

**PPN**  
 PPN



**40006018**  
**COW BRUSH REPLACEMENT, BLUE DL STYLE**  
 Spazzolone ricambio BLU per DL

CORR. 91526242

## DISPOSABLE EXAMINATION GLOVES - GUANTO MONOUSO DA ESAMINAZIONE

NITRILE - AMBIDEXTROUS - NON STERILE - POWDER FREE - FOOD CONTACT - 100 PCS/BOX  
 NITRILE - AMBIDESTRO - NON STERILE - SENZA POLVERE - IDONEO AL CONTATTO CON ALIMENTI - 100 PZ/CONF

### REGULAR (SUPER SENSITIVE - SUPER SENSIBILE)



- 40005500 - S
- 40005501 - M
- 40005502 - L
- 40005503 - XL

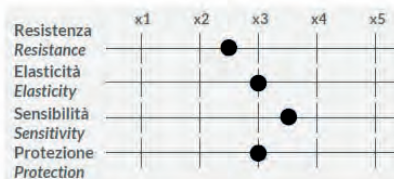

### PLUS (HIGH RESISTANT - ALTA RESISTENZA)



- 40005600 - S
- 40005601 - M
- 40005602 - L
- 40005603 - XL

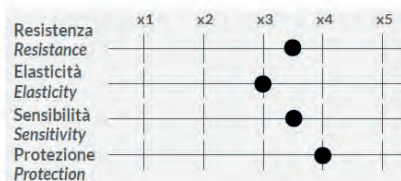

### PLUS 30 CM (HIGH RESISTANT - ALTA RESISTENZA)



- 40005606 - S
- 40005607 - M
- 40005608 - L
- 40005609 - XL

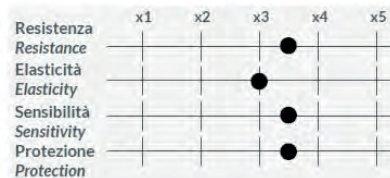

### STRONG (EXTRA RESISTANT - EXTRA RESISTENTE)



- 40005700 - S
- 40005701 - M
- 40005702 - L
- 40005703 - XL

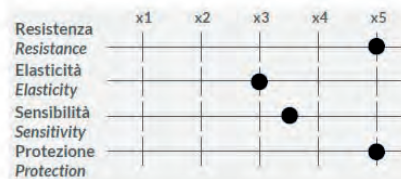

### 400 SAFE - 40 CM



- 40005706 - S (50 pcs)
- 40005707 - M (50 pcs)
- 40005708 - L (50 pcs)
- 40005709 - XL (50 pcs)

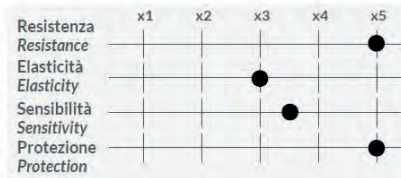

- 40005870  
**LDPE SLEEVE COVERS 40X20 - BLUE -100 PCS**  
 COPRIMANICHE LDPE 40X20 - BLU - 100 PCS