



CLUSTER - Gruppo



Tettarelle vari tipi

Nelle pagine seguenti troverete 3 tipi di guaine: JOLLY-DAIRY prodotte dalla nostra Ditta, MILK-RITE prodotte in Inghilterra da Avon Rubber, SPAGGIARI prodotte in Italia. Per facilitare il cliente nella scelta della guaina più consona alle proprie esigenze, di seguito riportiamo una tabella nella quale ad ogni codice originale delle diverse marche presenti sul mercato sono abbinati i riferimenti che possiamo proporre come alternativa.

JOLLY DAIRY		MILK-RITE	SPAGGIARI
BOSIO			
186644160	91000070		
BOUMATIC			
DK1F			50000486
DK1X	91000000	BM1XU-BM1XUV	50000561-50000689
DKFM		BMFMU	50000674
FLEX 40		BM40F-BM40FV	
FLEX 50		BM50F-BM50FV	
FLEX 60			50000730-50000730V
FLEX70		BM70F-BM70FV	
MAGNUM 400 MX	91000071		50000703-500703/01
R-1 D			50000487
R-1, R-1C		BMEXU-BMEXUV	50000562
R1EX			50000562-50000661
DAIRYMASTER			
916S	91000407-91000408		50699/01
916SL	91000403		50000734-50093/02-50000722
DL			
869407-01	91000401		50000716
906836-01	91000045	DL836U	50000672
906837-01			50000675
907595-01 (80)	91000077		
918701-01	91000018		50000733
927259-01 (VMS)	91000404-91000405		50000680
928178-01 (80)		DL178U	50000213
928179-01 (80)		DL179U	
928328-01 (80)	91000044	DL328U	50000659
960000-01 (81)	91000001-91000072	DL000U-AL1U	50000108 - 5000108L - 500108ML
	91000054-91000020		50108MSL - 5000108M - 500108SL
	91000019		50000744



CLUSTER - Gruppo

960001-01 (80)		DL001U	50000241
960001-04 (84)	91000052		50000287
960007-01 (80)	91000051		50000206
960008-01 (80)	91000050		50000199
960016-01 (83)	91000002-91000073	DL016U TLC-A2	50000156 - 50000441 500609SL - 50609MSL - 50000320 50000236M - 5000236M-500700SL
960017-01 (83)	91000049	DL017U-01	50000157 - 500157SL - 50000247
960017-02 (81)	91000048	DL017U	5179/247 - 50000266 - 5000266M
960018-01 (83)	91000076	AL18U	
960036-03 (82)	91000003-91000021	DL036U - TLC-A3	50000325
960037-02 (81)		DL037U-01	50000647
960037-02 (81)		DL037U	50000641
964007-01		DL4007U	50000657
964008-01 (80)	91000074-91000075	DL008U	50000714
985008-80			50000493
990666-01	91000131		50000672
990777-01			50000675
998228-01 (80)			50000331
999004-01			50000704
999006-01 (80)		AL6U	
999007-01 (80)	91000022	DL007U-01	50000590
999007-03 (83)	91000004- 91000080	DL007U - HFH029U - TLC-A6	50000672
999008-01 (80)	91000074-91000075	DI9008U	50000598-50000549
999009-01 (82)	91000004-91000080	DL009U - TLC-A5	50000444 - 500444SL
999099-01 (82)			50000668
999295-01 (80)		DL295U/DL295U-10	
FLACO			
60132510	91000081		
STAR EASE	91000084		
FULLWOOD			
020114		FW14U	
020122		FW22U	
020134	91000087		50000143 - 5000143M
020137	91000015-91000024	FW37U	500268TV
020138	91000062-91000120	FW38U	50000268 - 50000591
020146			50000555
020167			50000481
020168		FW68U	50000556
020169	91000088	FW69U	
020198		FW98U	
020215		FW15U	50000479 - 50000732



RICAMBI NON ORIGINALI - I nomi di società, marchi o prodotti sono solo a scopo identificativo.

NOT ORIGINAL SPARE PARTS - Company names, trademarks or products are for identification purposes only.

020227	91000089	FW27U	50000477
GASCOIGNE-MELOTTE			
381130			50000361
381169			50000147
381416	91000059	GM16U	50000574 - 50000148
381448			50000292
381922		GM22U	50000644
381974		GM74U	
381975		GM75U	
381985		GM85U	50000492
381986		GM86U	50000526
381987			50000558
381988		GM88U	50000528
381989			50000491
381991		GM91U	50000511
381995	91000090	GM95U	50000532
492027	91000025		
			50000331 - 5000331M
MK2-381981	91000005	GM2U	- 50000201 - 50000518 - 5000518M - 50000587
MK3			50000544
MK5			50000155
MK7	91000117 - 91000130		
IMPULSA			
NW23			50448/01 - 50000595
NW25	91000373		50448/02 - 50000596
INTERPULS			
1800001	91000375		
1800002			
1800011	91000006		
ITALIAN STYLE			
BABY CORTA			50000029
BABY LUNGA	91000029		50000114 - 50000552
MANOVAC			
MILFOS			
			50000697
MS			
901029-01 (80)			50000642
901031-80			50000535



CLUSTER - Gruppo

901163-01 (80)		MS163U	50000643
901197-01 (80)		MS197U	50000645
955390-01 (80)	91000094	MS390U	50000243
955507-01 (80)		MS507U	50000352
955875-80		MS875U	50000534
955897-01 (80)	91000095-91000118	MS897U	50000505
957706-80			50000142
958123-01 (80)		MS123U	50000174
MELTEC			
7720-0068-278		MEL278U	
7720-1384-450		MEL450U	
MIELE			
23178-01			50000149
68278-02	91000034-91000098		50000164 - 500164SL - 50000462
NATIONAL			
	91000053-91000096		50000154
OKTAV			
			50000523
ORION			
EUR.OR.1			50082/05
ORION N-3-B			50082/10
RUSSIAN STYLE			
0041.AA			50000663
SAC			
252.15.004			5179/151 - 5274/151
252.15.007	91000097	SAC007U	50000336 - 500336SL - 50000168
252.15.010	91000009-91000032	SAC010U	50000306 - 50000529 - 500529SL
252.15.012	91000008	SAC012U	50000443 - 50000567
252.15.013			50000568
252.15.020		SAC020U	50000638
252.15.022	91000033	SAC022U	50000639
STRANGKO			
3423005			50000502
3423007			50000497
3426008			50000677
3426009			50000652-50000433
3426010-01	91000056	STRKO-1	50000432
3426010-02			50000433
3426018	91000057		50000600 - 500600SL - 50000677
3426024			50000702
SURGE			
10025		WS025U	500500TV



RICAMBI NON ORIGINALI - I nomi di società, marchi o prodotti sono solo a scopo identificativo.
 NOT ORIGINAL SPARE PARTS - Company names, trademarks or products are for identification purposes only.

10029		WS029U	50000619
10060	91000104		
10062	91000104		
10067		WS067U	50000575 - 50000304
TECNOSAC			
	91000349		
TECNOZOO-TDM			
PG-004-SP	91000011		5243/100 - 50000514
PG-005-AC	91000010-91000047		50000517-500517SL
VITREX			
	91000053		
WAIKATO			
REFLEX M22	91000119		
WF			
7021-2725-029	91000390	WS029U-01	
7021-2725-030	91000107		50000215 - 5000215M - 50215MSL
7021-2725-040	91000101		50000449
7021-2725-070			50000334
7021-2725-110	91000014-91000036	WS110U	50000169 - 500169SL
7021-2725-220	91000035	WS220U	50000329
7021-2725-230		WS230U	50000531
7021-2725-240S	91000037-91000103	WS240U	50000615
7021-2725-270		WS270U/WS270U-01	50000616
7021-2725-350	91000406		50000658
7022-2725-010	91000013		50000144
7022-2725-020	91000012		
7022-2725-130			50000193
7022-2725-150	91000012	WS150U	50000153-500153SL
7022-2725-180	91000061	WS180U	
7023-2725-060			50000214
7023-2725-070	91000063		50000559
7023-2725-100	91000063	WS3-100U	50000559
7023-2725-110		WS3-110U	50000560
7023-2725-120	91000063	WS120U	50000559
7027-2725-000	60009666		
7027-2725-010	60009668-91000036		50450/01
7027-2725-020	60009674		50450/11
7029-2725-000	91001050		5000V698
7029-2725-010			5000V610
7036-2725-060			50000291
7036-2725-110		GWS110U	
7720-0068-278	91000098-91000034		50000164-500164SL
7750-0010-048	91000102		

JD = Jolly Dairy Draw the right liner!



Le guaine Jolly Dairy permettono una perfetta intercambiabilità con gli originali e garantiscono un'ottima qualità grazie alla miscela di gomma americana approvata dagli istituti di controllo europei (RAL G-39). Ora senza ftalati! Le nostre guaine non sono originali. Si intendono adattabili alle varie marche. I riferimenti e le descrizioni utilizzate in queste pagine sono evidenziate a solo scopo identificativo.



Replacement advised - Sostituzione consigliata

Recommended days of use

RUBBER (based on 3000 milkings and supposing 2 milkings per days)
GOMMA (basato su 3000 mungiture e supponendo 2 mungiture al giorno)
850 hours or 3000 milkings - 1000 ore o 3000 mungiture



	4	5	6	8	10	12	14	16	20	24	30
400	13	16	19	25	31	38	44	50	63	75	94
360	14	17	21	28	35	42	49	56	69	83	104
320	16	20	23	31	39	47	55	63	78	94	117
280	18	22	27	36	45	54	63	71	89	107	134
240	21	26	31	42	52	63	73	83	104	125	156
200	25	31	38	50	63	75	88	100	125	150	188
180	28	35	42	56	69	83	97	111	139	167	206
160	31	39	47	63	78	94	109	125	156	188	234
140	36	45	54	71	89	107	125	143	179	214	266
120	42	52	63	83	104	125	148	167	208	250	313
100	50	63	75	100	125	150	175	200	250	300	375
90	56	69	83	111	139	167	194	222	278	333	417
80	63	78	94	125	156	188	219	250	313	375	
70	71	89	107	143	179	214	250	286	357		
60	83	104	125	167	208	250	292	333			
50	100	125	150	200	250	300	350				
40	125	156	188	250	313	375					
30	167	206	250	333	417						

MAXIMUM 1 YEAR

SILICONE (based on 5000 milkings and supposing 2 milkings per days)
SILICONE (basato su 5000 mungiture e supponendo 2 mungiture al giorno)



	4	5	6	8	10	12	14	16	20	24	30
400	23	29	35	46	58	69	81	92	115	138	173
360	26	32	38	51	64	77	89	102	128	153	192
320	29	36	43	58	72	86	101	115	144	173	218
280	33	41	49	66	82	99	115	131	164	197	246
240	38	48	58	77	96	115	134	153	192	230	288
200	46	58	69	92	115	138	161	184	230	276	345
180	51	64	77	102	128	153	179	204	256	307	383
160	58	72	86	115	144	173	201	230	288	345	
140	66	82	99	131	164	197	230	263	329		
120	77	96	115	153	192	230	268	307	383		
100	92	115	138	184	230	276	322	368			
90	102	126	153	204	256	307	356				
80	115	144	173	230	288	345					
70	131	164	197	263	329	394					
60	153	192	230	307	383						
50	184	230	276	368							
40	230	288	345								
30	307	383									

MAXIMUM 1 YEAR

1650 hours o 5000 milkings
1650 ore o 5000 mungiture

BOSIO

91000070

186644160

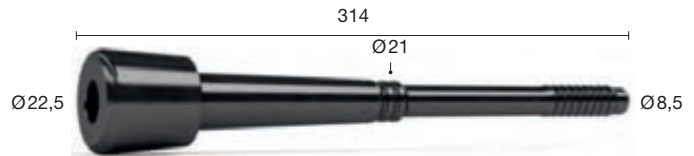
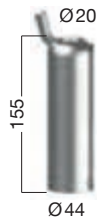

BOU-MATIC

91000068

MAGNUM 400 MX
"non vented"

91000069

MAGNUM 400 MX
"vented"



91000000

DK1X



91000071

R-1, R-1C



DAIRYMASTER

91000403

916SL



91000407

916S



91000408

916S
(Non shut-off)



DL

91000050

960008-80
(4x960008-01)



91000051

960007-80
(4x960007-01)



91000001

960000-81
(4x960000-01)

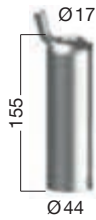

91000072

960000-81
(4x960000-01)

SILICONE

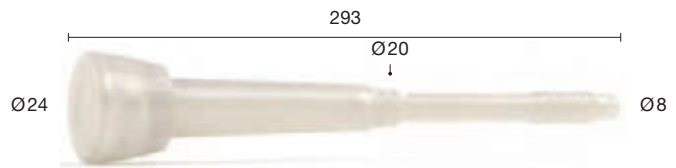
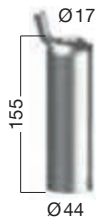

91000019

960000-81
(4x960000-01)
960000-02

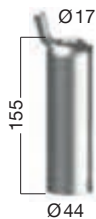

91000054

960000-81
(4x960000-01)

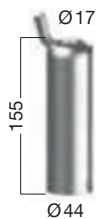

91000020

960000-81
(4x960000-01)

SILICONE

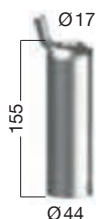

DL

9100002

960016-83
(4x960016-01)



9100073

960016-83
(4x960016-01)

SILICONE

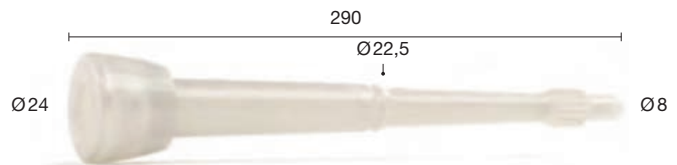

9100048

960017-81
(4x960017-02)



9100049

960017-83
(4x960017-01)



9100052

960001-84
(4x960001-04)

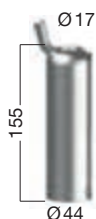

9100003

9600036-82
(4x960036-03)



9100021

9600036-82
(4x960036-03)

SILICONE

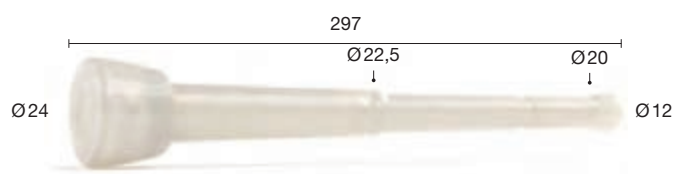
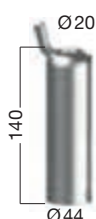

DL

9100004

999007-83
(4x999007-03)
999009-82
(4x999009-01)

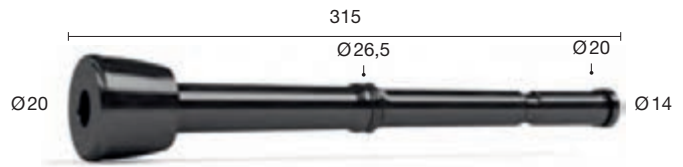
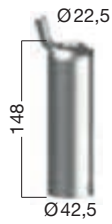

9100080

999007-83
(4x999007-03)
999009-82
(4x999009-01)

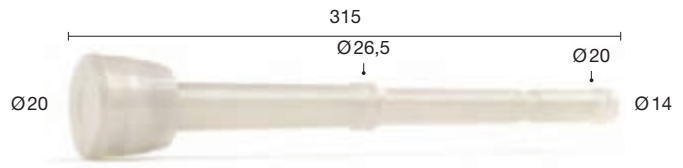

SILICONE

9100022

999007-80
(4x999007-01)



9100074

964008-01
999008-01



9100075

964008-01
999008-01

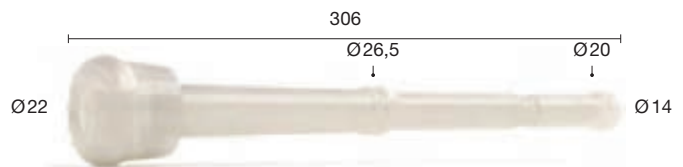

SILICONE

9100076

960018-83
(4x960018-01)

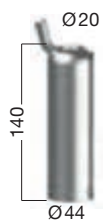

9100077

907595-80
(4x907595-01)

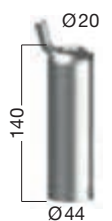

DL

91000044

928328-01
LEGEND

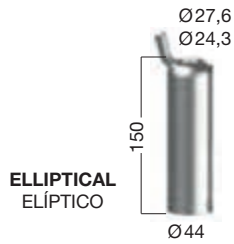

91000045

906836-01

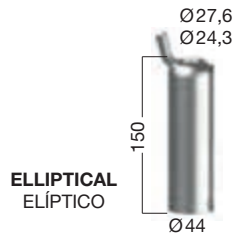

91000018

918701-01

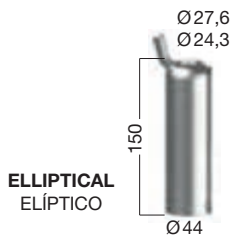

91000401

86940701



91000131

99066601

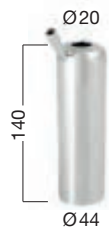

91000404

VMS 92725901

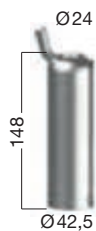

91000405

VMS
92725901
SILICONE

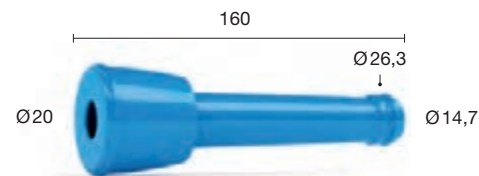
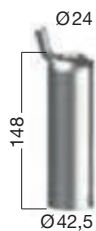

FLACO

91000081

60132510

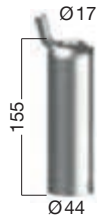

91000084

FLACO STAR
EASE



FULLWOOD

91000087

020134-SL-2CT



91000015

020137

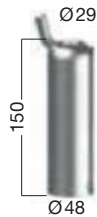

91000024

020137

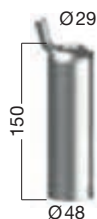

91000062

020138-SL2-CTF-WT

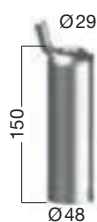

91000120

020138-SL2-CTF-WT

SILICONE

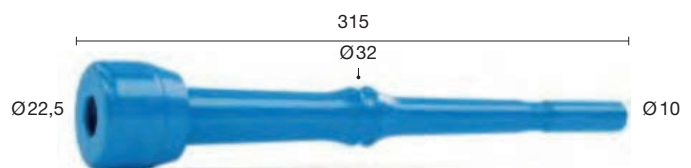
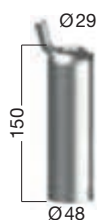

FULLWOOD

91000088

020169

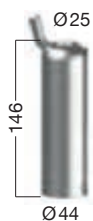

91000089

020227



GASCOIGNE-MELOTTE

91000005

MK2



91000090

381995



91000059

381416



91000025

492027



91000130

MK7

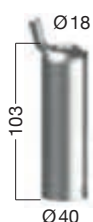

GASCOIGNE-MELOTTÉ

91000117

MK7

SILICONE

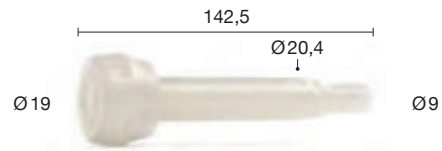
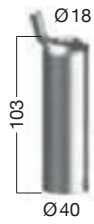

INTERPULS

91000373

1800001

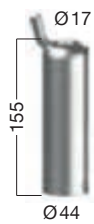

91000374

1800002



91000375

1800011

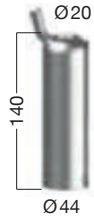

ITALIAN STYLE

91000006

BABY CORTA

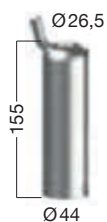

91000007

BABY LUNGA

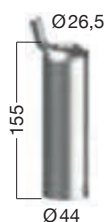

91000028

BABY LUNGA

SILICONE

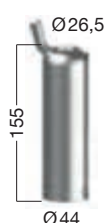

MANOVAC

91000029

40420059



MS

91000094

955390-80
 (4x955390-01)
 NOGUEIRA 2011384



91000095

955897-80
 (4x955897-01)



91000118

955897-80
 (4x955897-01)

SILICONE

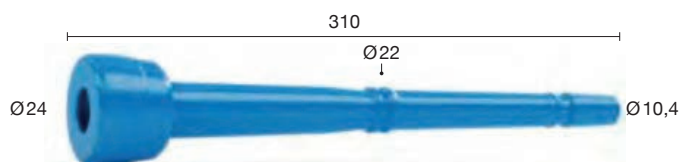

SKELLERUP

91000402

M22-M23

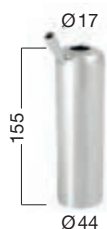

SAC-SENIOR

91000032

RODEG-SENIOR
 252.15.010



CLUSTER - Gruppo

91000009
252.15.010



91000008
252.15.012

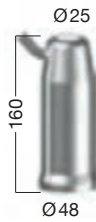

91000097
252.15.15007

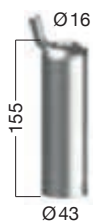

91000033
252.15.022

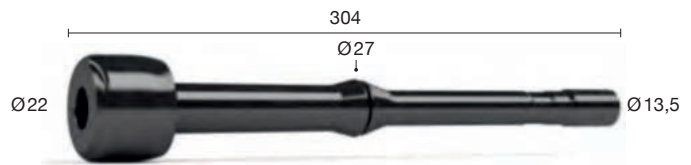

STRANGKO

91000056
3426010-01



91000057
3426018



SURGE

91000104
10-060
10-062

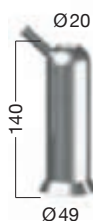

TECNOSAC

91000349

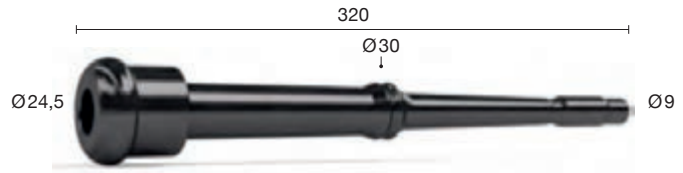

TECNOZOO - TDM

91000010

PG-005-AC

TDM: MG01
 MG03
 MC122

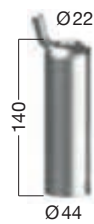

91000047

PG-005-AC

SILICONE

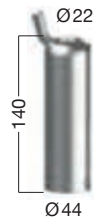

91000011

PG-004-SP
 (anche per bufale)

TDM: MG02

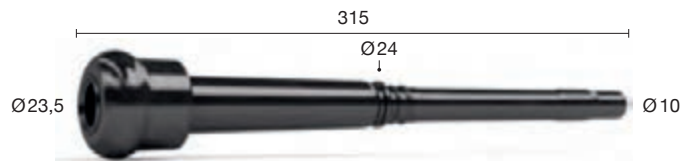
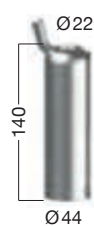

VITREX (NATIONAL)

91000053

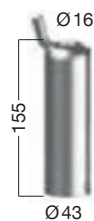

WAIKATO

91000119

REFLEX M22

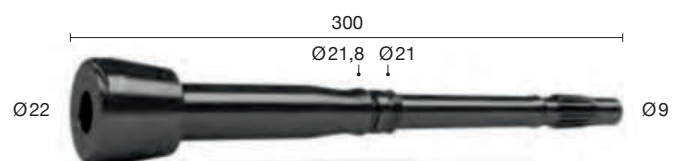
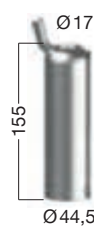

WF-SURGE

91000098

7720-0068-278/
68278-02



91000034

7720-0068-278/
68278-02

SILICONE

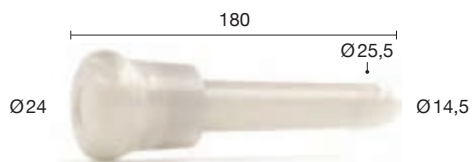

91000063

7023-2725-070/100/120



91000035

7021-2725-220



91000101

7021-2725-040



91000012

7022-2725-020



91000061

7022-2725-180



91000013

7022-2725-010



WF-SURGE

91000014

7021-2725-110



91000036

7021-2725-110
e STIMULOR 7027-2725-010

SILICONE



91000102

7750-0010-048

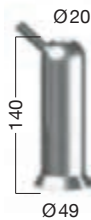

91000103

7021-2725-240S



91000037

7021-2725-240S

SILICONE

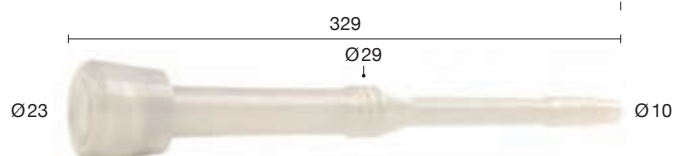

91000107

7021-2725-030



91000390

7021-2725-029

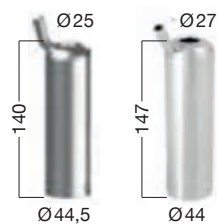

91000406

7021-2725-350



LINER FITT. CLASSIC-PRO/STIMULOR

91001050 Ø 22 FITT. 7029-2725-000

91001052 Ø 23 FITT. 7029-2725-010



ORIGINAL STIMULOR® SILICONE LINER

60009664 - Ø21

60009666 - Ø22 (CORR. WF 7027-2725-000)

60009668 - Ø23 (CORR. WF 7027-2725-010)

60009672 - Ø24

60009674 - Ø25 (CORR. WF 7027-2725-020)



91002000

RUBBER TUBE, BLACK FITT. IQ

Tubetto T. IQ in gomma nera

91002001

RUBBER TUBE, GREEN SILICONE FITT. IQ

Tubetto silicone verde T. IQ



SILICONE LINER FITT. LELY

Guaina silicone per LELY



91000129

Ø 21 (corr. 5.9700.2008.0)

91000132

Ø 19 (CORR. 5.9700.2072.0)

00401436

STICK FOR WF LINER MOUNTING

BASTONCINO MONTAGGIO GUAINA WF

CORR. 7027-9826-070



00401437

METALLIC EXTRACTOR FOR WF LINERS
AND TUBES

ESTRATTORE METALLICO PER GUAINA
E TUBI WF

CORR. 7027-9875-000

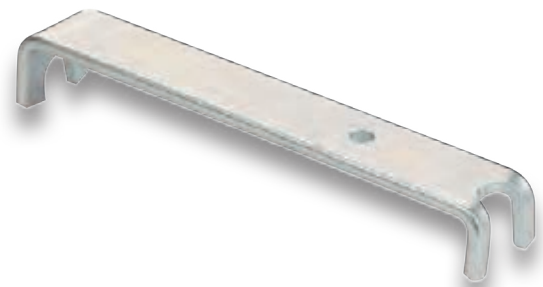

00300041

PLASTIC ROD FOR MOUNTING SHORT
LINERS

BASTONCINO IN PLASTICA PER MON-
TAGGIO TETTARELLE CORTE



SIGHT GLASSES / BICCHIERINI

60009670

SIGHT GLASS FOR STIMULOR®
 BICCHIERINO PER GUAINA STIMULOR
 (CORR. WF. 7021-2088-100 e 7021-9926-260)



2016-020158

SIGHT GLASS
 FULLWOOD FITT. 020158
 BICCHIERINO TIPO
 FULLWOOD 020158



2018-4987

O'R FOR /
 PER 2016-020158



00100089

ITALIAN STYLE



00100090

FITT. DL



00100093

FITT. MS



00100094

FITT. FW



00100095

FITT. FULLWOOD



00100092

FITT. WF



20070108

FITT. WF



20076066

FITT. WF
 7021-2088-060



00111192

FITT. WF Ø14
 7021-2188-020



00300507

FITT. MIELE

00300092

FITT. WF Ø16
 7021-2188-050



SPAGGIARI[®]
industria gomma s.r.l.

Production in conformity with the "B.G.A." (D) MARK RAL - D - 2

BOU MATIC

50000486

DK1F
8506718
8506752



50000561

DK1X



50000487

R-1 D



50000562

R-1 C
R-1EX



50000674

DKFM

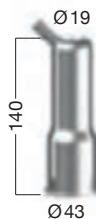

50000703

MAGNUM 400 MX

500703/01
MAGNUM 400 MX VENT.



BOU MATIC

50000730

FLEX 60

8589520
(ex 8584664)



50000730V

FLEX 60 VENTED

8589521
(ex 8584664)



DL

50000206

960007-01



50000199

960008-01

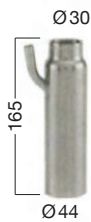

50000213

727537-01
(928178-01)

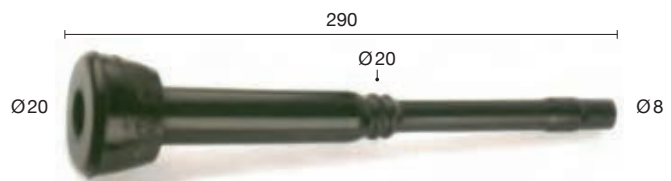
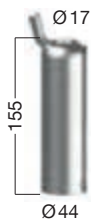

50000108

960000-81
(960000-01)

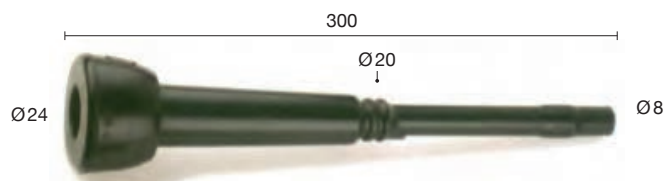
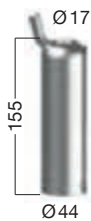

5000108M

960000-81 (960000-01)

50000744

AS 5000108M WITH HOLE Ø23
(come 5000108M con foro 23)

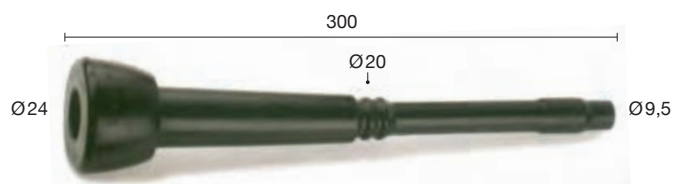

DL

5000108L

960000-81
(960000-01)

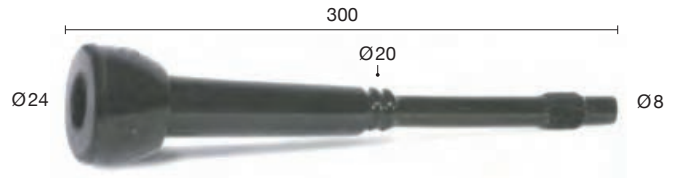

500108ML

960000-81
(960000-01)

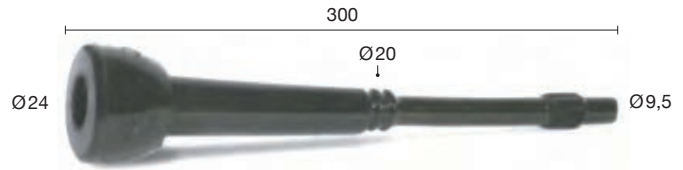

500108SL

960000-81
(960000-01)

SILICONE

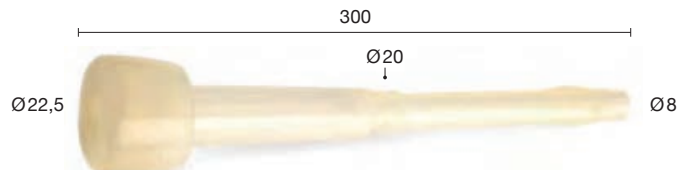
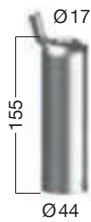

50108MSL

960000-81
(960000-01)

SILICONE

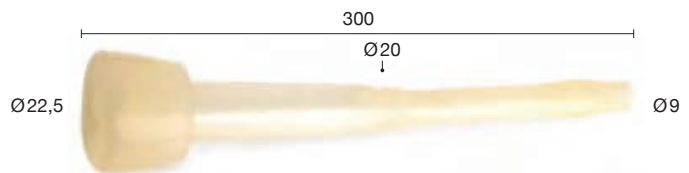

50000287

960001-84
(960001-02)



50000241

960001-80
(960001-01)

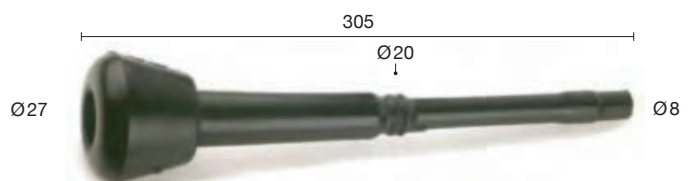

50000441

960016-83
(960016-01)

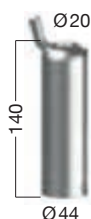

DL

50000156

960016-83
(960016-01)



500609SL

960016-83
(960016-01)

SILICONE

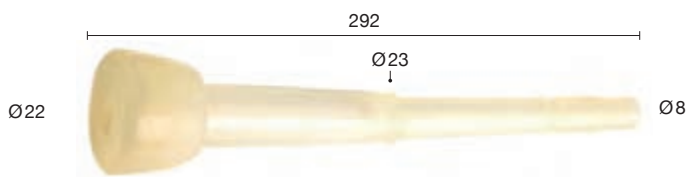

50000320

960016-83
(960016-01)

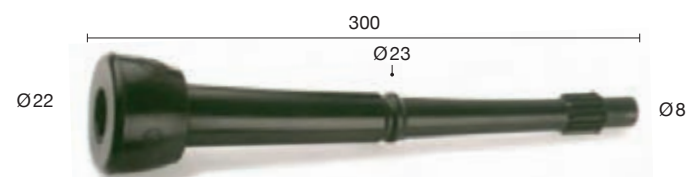

50000236

960016-83
(960016-01)



GR. 200

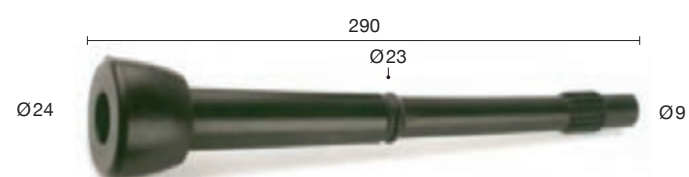

5000236M

960016-83
(960016-01)

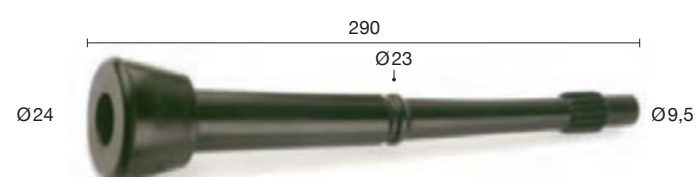

5179/247

960017-81
(960017-02)

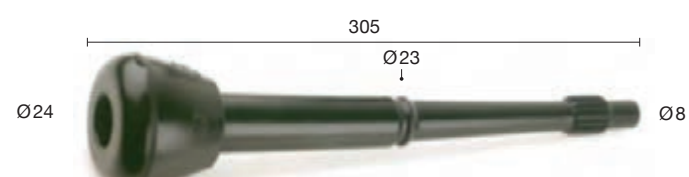

DL

50000247

960017-83
(960017-01)

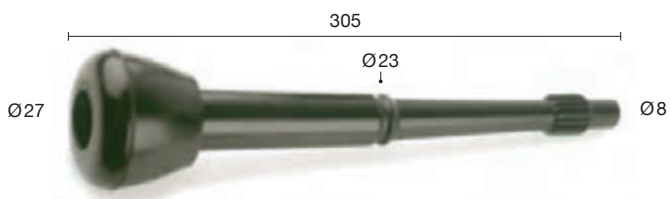

50000266

960017-81
(960017-02)

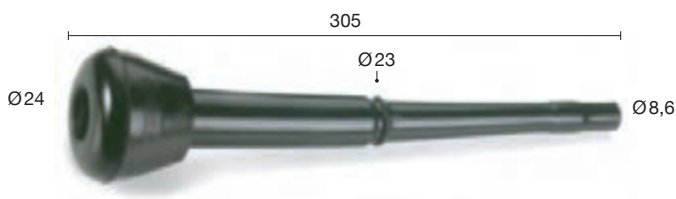

5000266M

960017-81
(960017-02)



50000157

960017-83
(960017-01)



500157SL

960017-81
(960017-02)

SILICONE



50000493

985008-80



50000325

960036-82
(960036-03)



DL

50000641

960037-81
(960037-02)

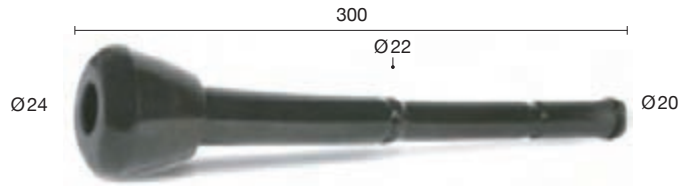
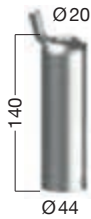

50000647

960037-80
(960037-01)

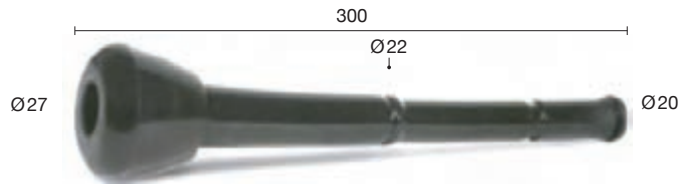
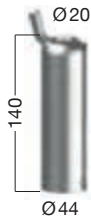

50000444

999009-82
(999009-01)



500444SL

999009-82
(999009-01)

SILICONE



50000599

999007-83
(999007-03)



50000590

999007-80
(999007-01)

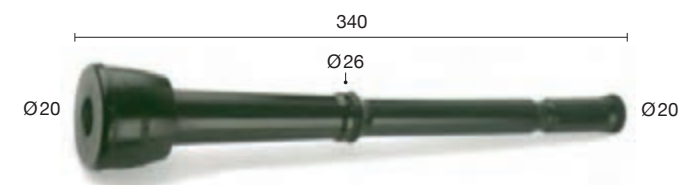

5000598

999008-80
(999008-01)



DL

50000549

999008-01



50000657

964007-01



50000668

999099-82
(999099-01)



50000672

990666-01

906836-01

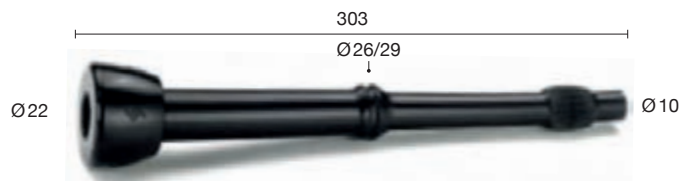

50000675

990777-01

906837-01

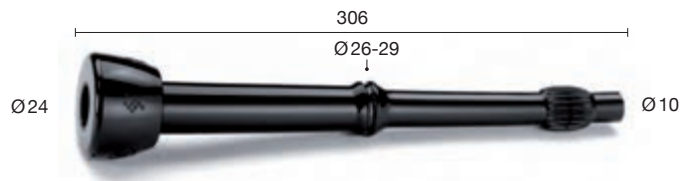
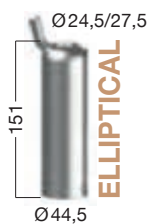

50000659

928328-80

(928328-01)

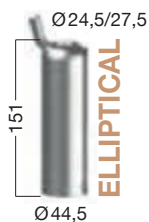

REINFORCEMENT FOR SILICONE LINERS/RINFORZO PER GUAINA IN SILICONE

50000546

Ø21

50000547

Ø19



50000680

927259-01

For ROBOT (VMS)

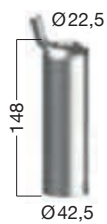

50000716

869407-01
"CLOVER"



50000704

999004-01



50000714

964008-01



500700SL

960016-01

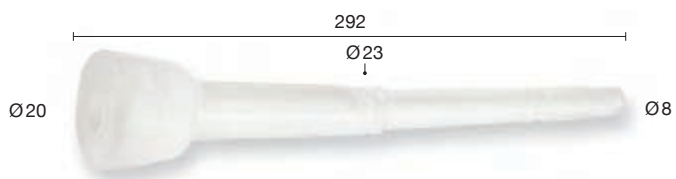
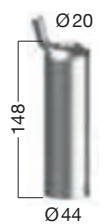

50000733

918701-01

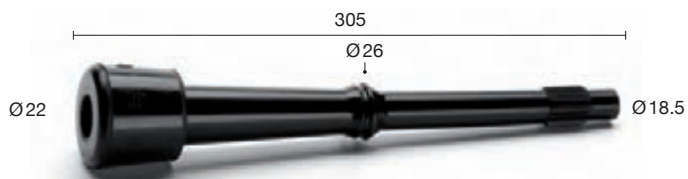

DAIRYMASTER

50699/01

916S

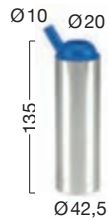

50000734

916SL

50093/02

As 50000734 in SILICONE

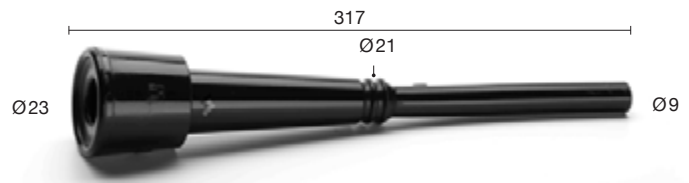
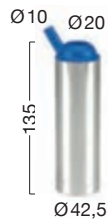

50000722

916SL

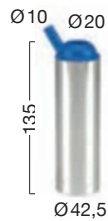

FULLWOOD

50000732

020215

SQUARED BARREL

CORPO QUADRATO

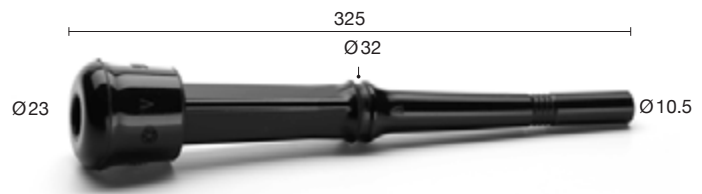

50000143

020134 SL2 CT



500268TV

020137



50000268

020138



FULLWOOD

50000591

020138 SL2 CTF WT

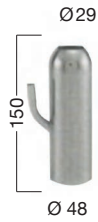

50000477

020227



50000479

020215



50479/01

020215



50000481

020167



50000555

020146



50000556

020168



GASCOIGNE MELOTTE

50000558

381987

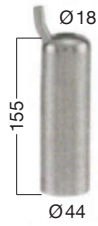

50000518

MK2

381981

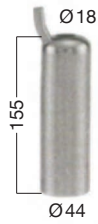

5000518M

MK2

381981

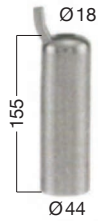

50000331

MK2

DL 998228

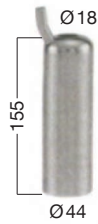

5000331M

MK2

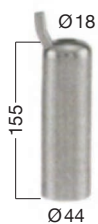

50000511

381991

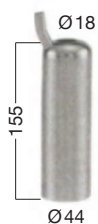

50000526

381986

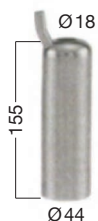

50000528
381988

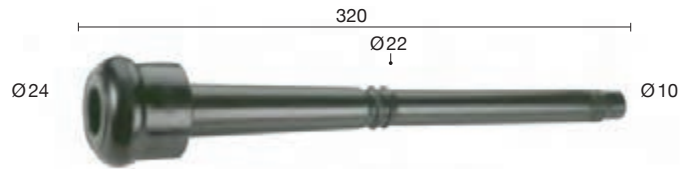
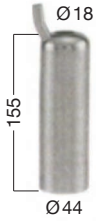

50000644
381922

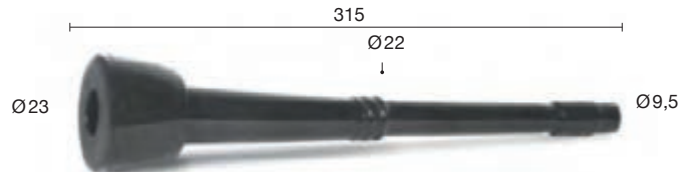
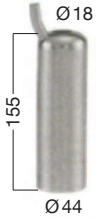

50000147
D381169

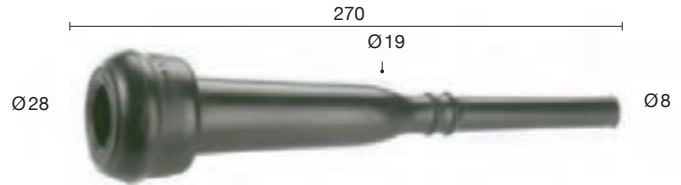

50000148
381416



50000491
381989



50000492
381985



50000532
381995



IMPULSA

50448/01

NW23



50448/02

NW25



50000595

NW23

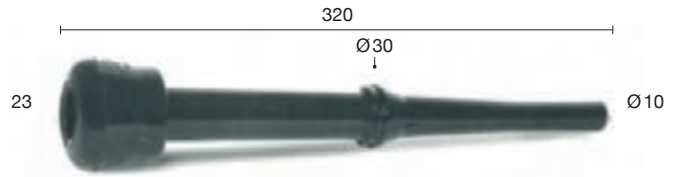

50000596

NW25

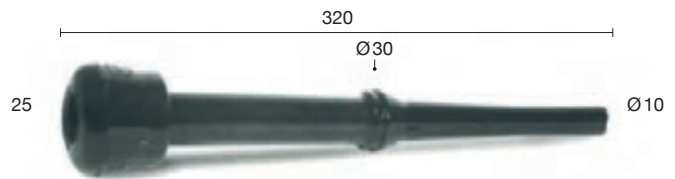

ITALIAN STYLE

50000029

BABY CORTA

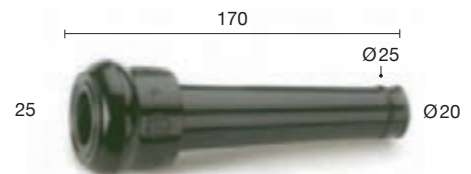
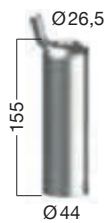

50000114

BABY LUNGA

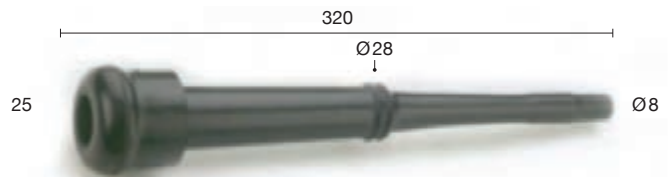
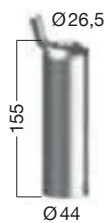

50000552

BABY LUNGA

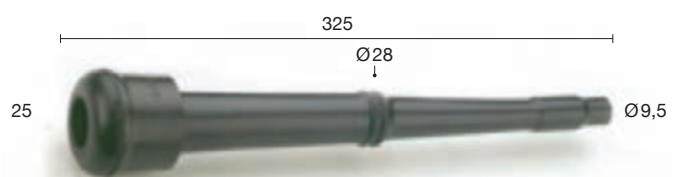
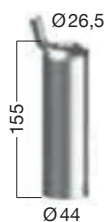

LELY

50000611



50000735



MS

50000142

957706

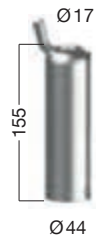

50000174

958123-01

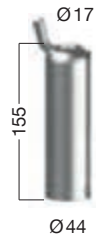

50000642

901029-01

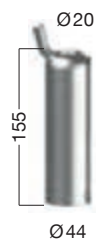

50000643

901163-01

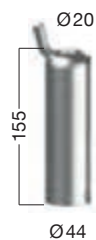

50000645

901197-01

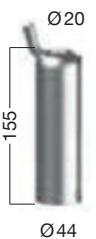

MS

50000243

955390-80

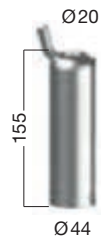

50000352

955507-01

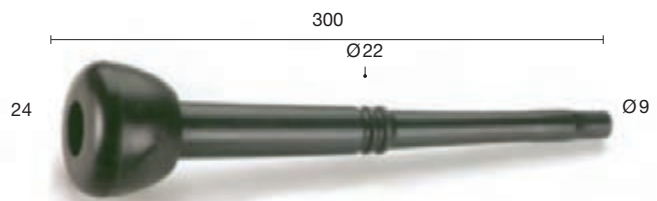
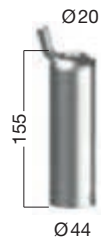

50000505

955897-01

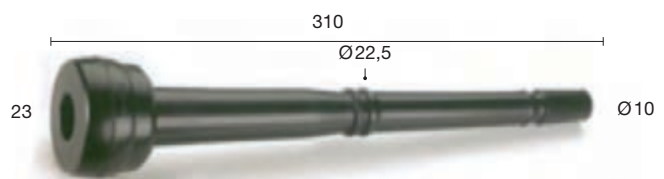
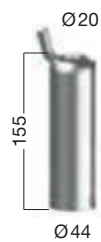

50000534

955875

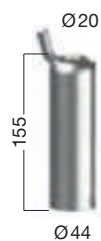

50000535

901031-80

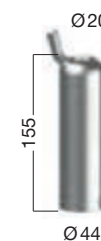

MILFOS

50000697

1020L

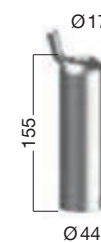

MIELE

50000149
 23178-01



50000462
 68278



50000164
 68278



500164SL
 68278
 SILICONE



NATIONAL

50000154

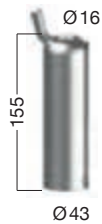

RUSSIAN STYLE

50000663
 0041.AA

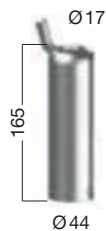

ORION

50082/05

EUR.OR.1

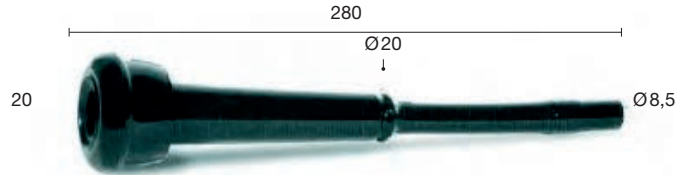
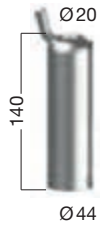

50082/10

ORION N-3-B

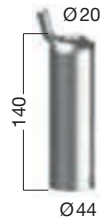

SAC CHRISTENSEN

50000306

252.15.15010

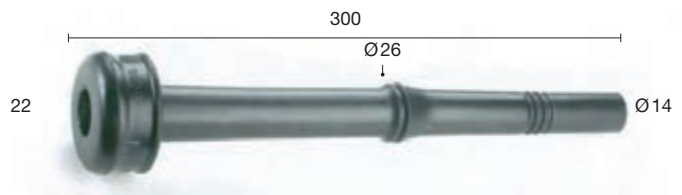
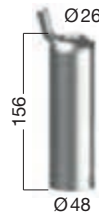

50000443

252.15.15012

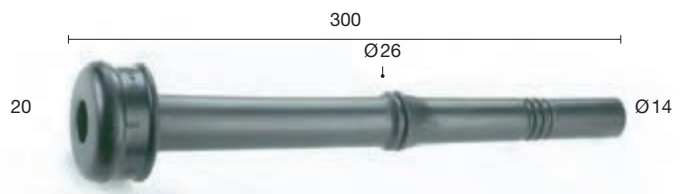
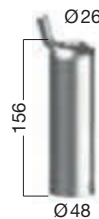

50000567

252.15.15012

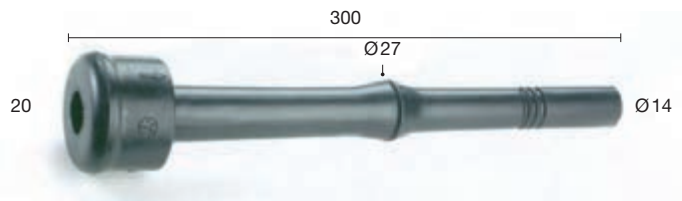

50000529

252.15.15010

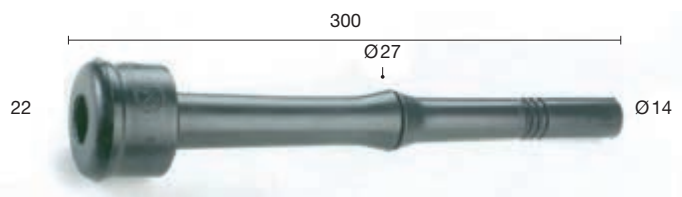

50000568

252.15.15013

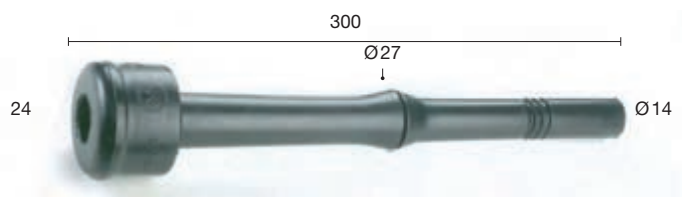

SAC CHRISTENSEN

500529SL

252.15.15010



5274/151

252.15.15004

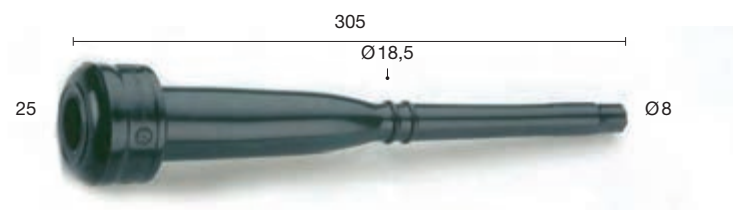
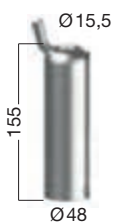

5179/151

252.15.15004

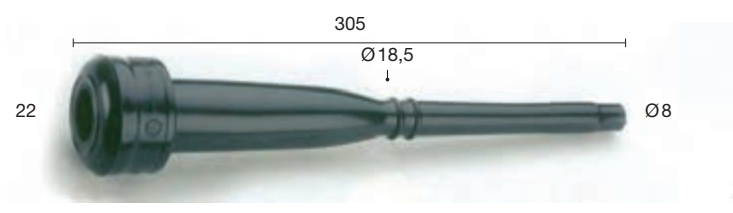
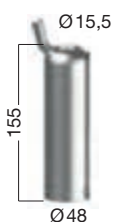

50000168

252.15.15007

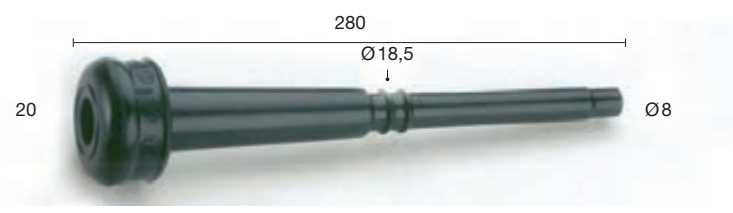
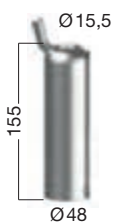

50000336

252.15.15007

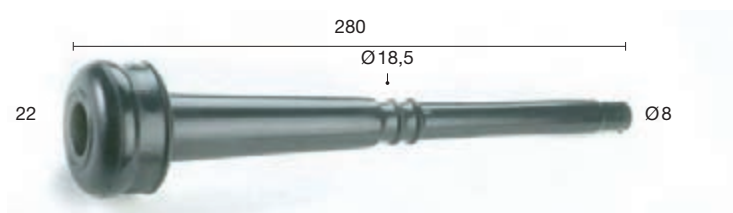
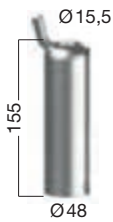

500336SL

252.15.15007

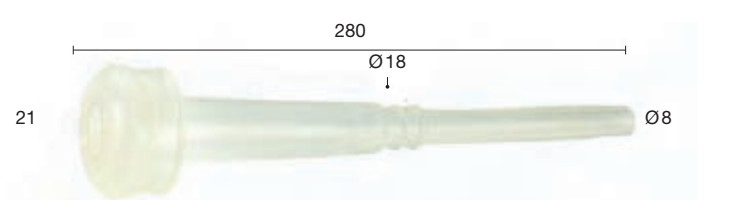
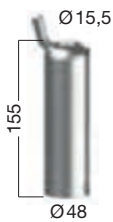

50000638

252.15.020

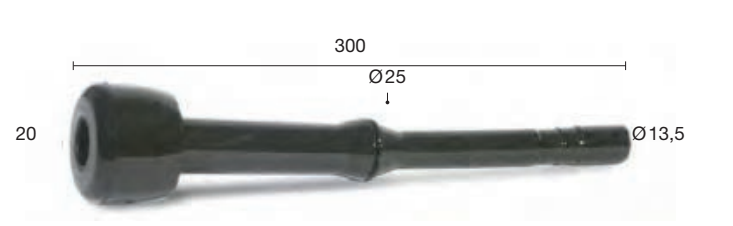
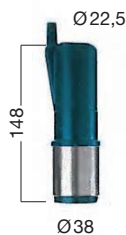

SAC CHRISTENSEN

50000639

252.15.022

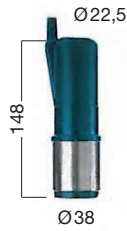

SCATIGNA IMPIANTI - EFFEKTIV-ROYAL

50000110

ART. 10000222



STRANGKO

50000502

3423005

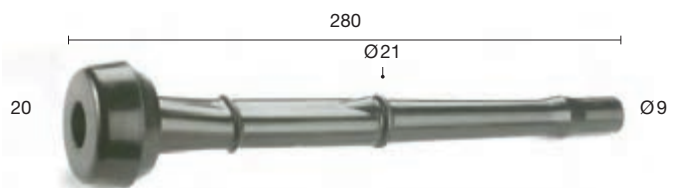
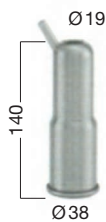

50000497

3423007

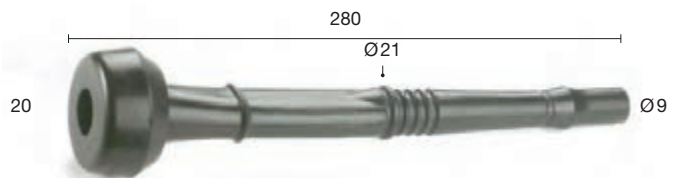
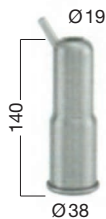

50000433

3426009

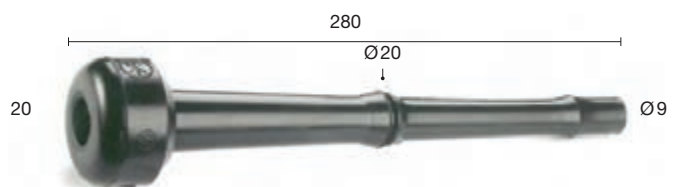
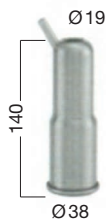

50000432

3426010/1

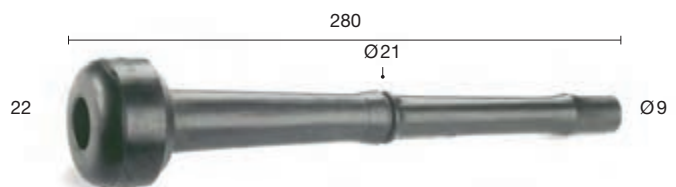
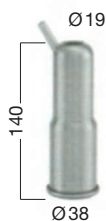

STRANGKO

50000600

3426018

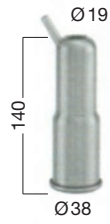

500600SL

SH 3426-018

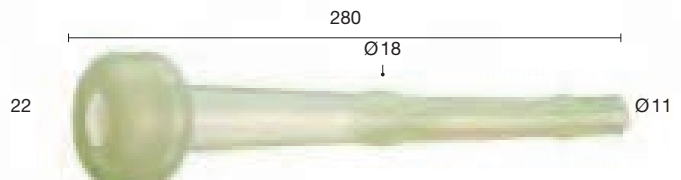
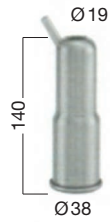

50000652

3426009

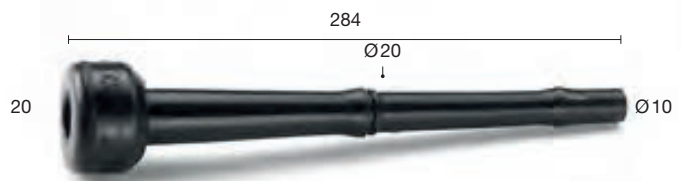
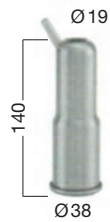

50000677

3426008

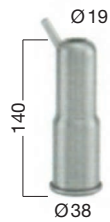

50000702

3426024

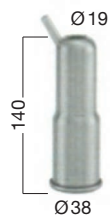

SURGE

50000304

10067

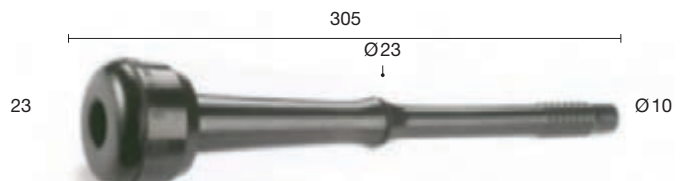
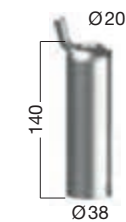

50000575

10067

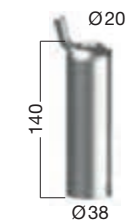

SURGE

500500TV

10025

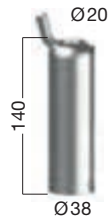

TECNOZOO

5243/100

004

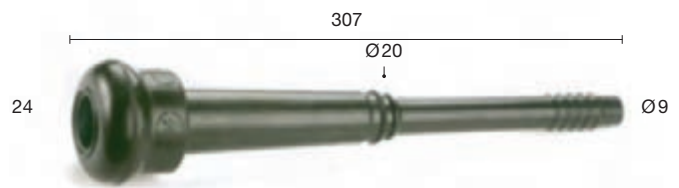
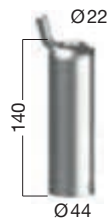

50000514

004

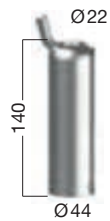

50000517

005/AC

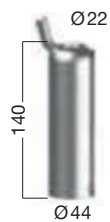

500517SL

005/AC

SILICONE

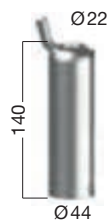

WF

50000334

7021.2725.070

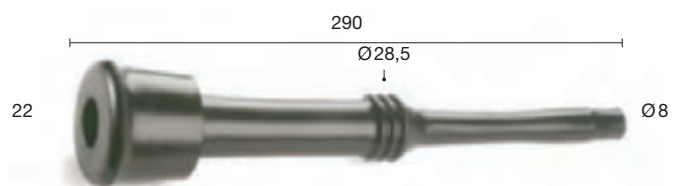
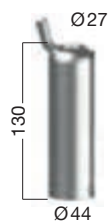

WF

50000560

7023.2725.110

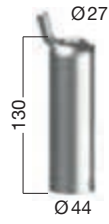

50000559

7023.2725.100

7023.2725.120

7023.2725.070

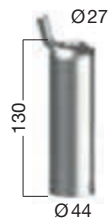

50000214

7023.2725.060

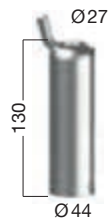

50000153

7022.2725.150

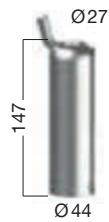

500153SL

7022.2725.150

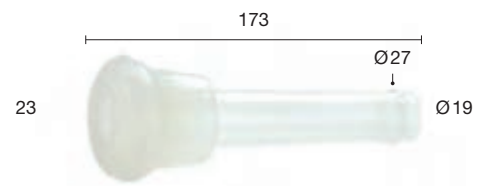
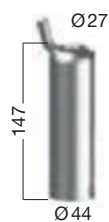

50000531

7021.2725.230

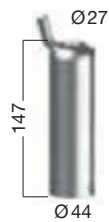

50000169

7021.2725.110

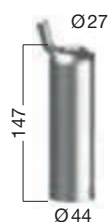

WF

500169SL

7021.2725.110

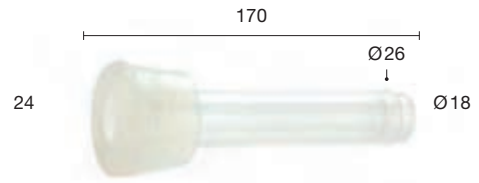
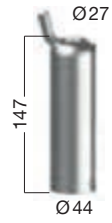

50000329

7021.2725.220

7021.2909.160

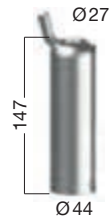

50000449

7021.2725.040

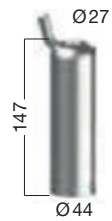

5000V610

7029.2725.010

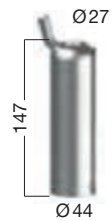

5000V698

7029.2725.000

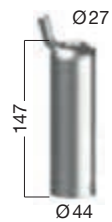

50000193

7022.2725.130

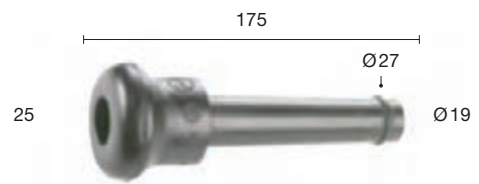
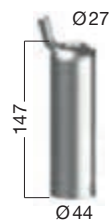

50000658

7021.2725.350

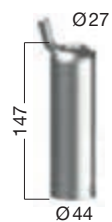

WF

50000144

7022.2725.010

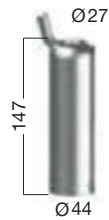

50000215

7021.2725.030

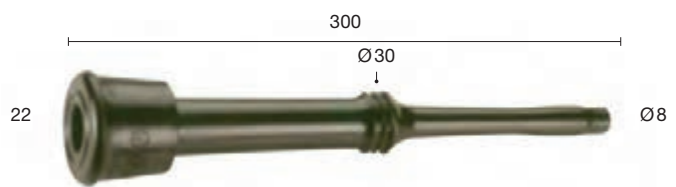
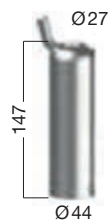

5000215M

7021.2725.030

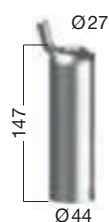

50215MSL

7021.2725.030

SILICONE

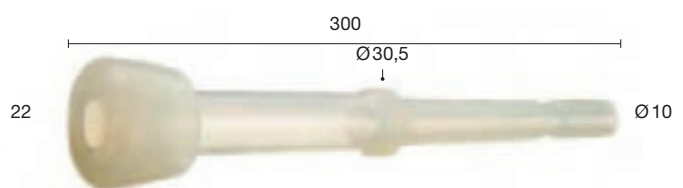
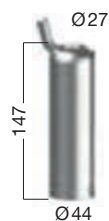

50000615

7021.2725.240

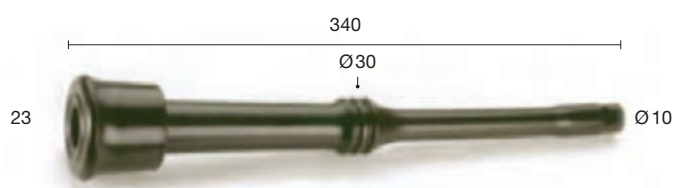
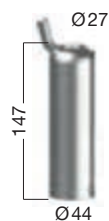

50000616

7021.2725.270

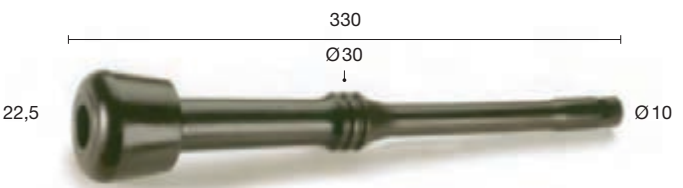
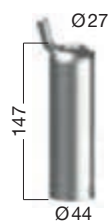

50000291

7036.2725.060

GOATS - CAPRE

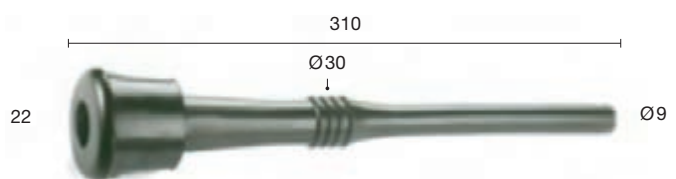

SHELLS - CANNELLI



1



2



3

Art.	Type	Ref.	Measure	Weight in grams
1	STD	00100463	L. 155 Ø 26.5	400
1	DL (96055082)	00100464	L. 155 Ø 17	400
1	DL	00100465	L. 155 Ø 18	410
1	DL (96055080)	00100466	L. 140 Ø 20	360
1	DL (96055080)	00111466	L. 140 Ø 20	200
1	WF (7021-2721-090)	00100467	L. 147 Ø 27	380
1	WF	20160467	L. 147 Ø 27	230
1	DL (Harmony)	00100850	L. 148 Ø 22.5	240
1	DL (Harmony)	00111850	L. 148 Ø 24	240
1	TECNOZOO	20070187	L. 140 Ø 22	230
2	BOUMATIC (8517327)	00100591	L. 141 Ø 19	185
3	DL (Harmony 96442082) PLASTIC	00300100	L. 148 Ø 24	125
-	SURGE (7750-0101-500)	00100590	L. 140 Ø 20.5	205

00800135

**SHELL BLUE PLASTIC
CORR. SAC 212.14.817**

Cannello plastica blu tipo SAC 212.14.817



INFLATION STOP- CAPEZZOLI ARTIFICIALI



00100069
I.S.O. RULES
 A norma I.S.O.



00100524
UNIVERSAL
 universale
 (corr. FW 020406)



00300129
UNIVERSAL
 universale



00400106
RUBBER/
 Gomma
 (88X16X38)



00300404
WITH
HANDLE
 Con maniglia



00800156
CORR. DL
 95680301



00800235
 (corr. FW 020407)

00800292
PLUG FOR LINER WITH CHAIN
 Tappo plastica con catenella



00800123
AIR INLET IQ MILKING CLAW
 Entrata aria per collettore IQ

CORR. 7025-3709-000



CLUSTER - GRUPPI MUNGITORI

4



5



Art.	Ref.	DESCR.
4	00100753	"HRMY" MODEL Modello "HRMY"
5	00100001	"TRILINER" MODEL Modello "Triliner" WITH TRIANGULAR LINERS TLC-A5 Con guaine triangolari TLC-A5



CLUSTER - Gruppo

LINERS - Tettarelle

MILKRITE REF.	OEM REF.	A (mm)	B (mm)	C (mm)	D (mm)
---------------	----------	--------	--------	--------	--------

BOUMATIC COMPATIBLE

BM1XU	DK1X	300	23	11	22
BM1XUV*	DK1X*	300	23	11	22
BMEXU	R1EX	266	21	11	22
BMEXUV*	R1EX*	266	21	11	22
BMFMU	DKFM	308	24	11	22
BM40F	FLEX40	301	25,1	10,6	23,1
BM40FV*	FLEX40	301	25,1	10,6	23,1
BM50F	FLEX50	301	25,1	10,6	23
BM50FV*	FLEX50	301	25,1	10,6	23
BM70F	FLEX70	287	24	10,5	23
BM70FV*	FLEX70	287	24	10,5	23

*V = with milk tube venting

DAIRYMASTER COMPATIBLE

DM916U	916	310	22	7	27
--------	-----	-----	----	---	----

DELAVAL COMPATIBLE

DL000U	960000-01	295	24	8	25
DL001U	960001-01	300	27	8	24
DL007U	999007-03	310	20	13	23
HFH029U	999007-03	310	22	12,5	22,5
DL007U-01	999007-01	340	20	13	23
DL008U	964008-01	305	22	13	23
DL009U	999009-01	310	20	13	22
DL016U	960016-01	293	24	8	25
DL017U	960017-02	303	24	8	25
DL017U-01	960017-01	302	27	8	25
DL036U	960036-01	295	24	13	25
DL037U	960037-02	302	24	12	26
DL037U-01	960037-01	302	27	12	26
DL178U	928178-01	288	21	8	22
DL179U	928179-01	295	23	9	24
DL295U	999295-01	313	24	8	25
DL295U-10	999295-01	313	24	10	25
DL328U	928328-01	306	24	11	23,7
DL4007U	964007-01	310	20	13	22

UTILIZZABILE SU ROBOT LELY

DL836U	906836-01	304,2	22,2	10	N/A
DL9008U	999008-01	337	21,5	12,5	23
<i>TLC triangular liners</i>					
TLC-A2	960016-01	292	22	11	N/A
TLC-A5	999009-01	306	21	12	N/A
TLC-A6	999007-03	310	20	13	N/A

MILKRITE REF.	OEM REF.	A (mm)	B (mm)	C (mm)	D (mm)
---------------	----------	--------	--------	--------	--------

FULLWOOD COMPATIBLE

FW14U	020114	320	21	8	24
FW15U	020215	327	25	10	25
FW22U	020122	164.6	22	N/A	25
FW27U	020227	327	22	8	25
FW37U	020137	313	23	8	26
FW38U	020138	313	23	10	26
FW68U	020168	303	23	10	22
FW69U	020169	303	21	10	22
FW98U	020198	303	20.8	12	21.5

GASCOIGNE COMPATIBLE

GM2U	MK2H	311	27	8	25
GM16U	381416	310	24	8	25
GM22U	381922	318	23	10	25
GM74U	381974	315	20	9	23
GM75U	381975	315	23	8	26
GM85U	381985	325	24	10	25
GM86U	381986	319	21	10	23
GM88U	381988	319	24	10	23
GM91U	381991	319	23	10	26
GM95U	381995	325	24	10	25

MELTEC COMPATIBLE

MEL278U	7720-0068-278	179	24	N/A	25
---------	---------------	-----	----	-----	----





RICAMBI NON ORIGINALI - I nomi di società, marchi o prodotti sono solo a scopo identificativo.
 NOT ORIGINAL SPARE PARTS - Company names, trademarks or products are for identification purposes only.

LINERS - Tettarelle

MILKRITE REF.	OEM REF.	A (mm)	B (mm)	C (mm)	D (mm)
MANUS COMPATIBLE					
MS031U	901031-01	310	23	10	24
MS123U	958123-01	294	24	8	28
MS163U	901163-01	316	23	9	27
MS197U	901197-01	315	23	11	26
MS390U	955390-01	300	24	9	25
MS507U	955507-01	300	24	9	25
MS875U	955875-01	310	22.7	9	23.5
MS897U	955897-01	308	24	11	25
SAC COMPATIBLE					
SAC007U	25215007	278	20	8	24
SAC010U	25215010	300	22	14	23
SAC012U	25215012	300	20	14	23
SAC020U	25215020	305	21	14	23
SAC022U	25215022	305	22	14	23
GEA-WESTFALIA COMPATIBLE					
WS025U	10025	279	22	10	21
WS029U	10029	289	22	10	22
WS029U-01	7021-2725-029	316	22,2	10	N/A
WS067U	10067	305	23	10	24
WS110U	7021-2725-110	173	23	N/A	24
WS120U	7023-2725-120	156	23	N/A	25
WS150U	7022-2725-150	181	25	N/A	25
WS180U	7022-2725-180	181	24.75	N/A	25.3
WS220U	7021-2725-220	173	23	N/A	25
WS230U	7021-2725-230	173	23	N/A	25
WS240U	7021-2725-240	334	23	9	25
WS270U	7021-2725-270	326	22	10	23
WS270U-01	N/A	159	22	N/A	23
WS3-110U	7023-2725-110	166	25	N/A	26
WS3-100U	7023-2725-100	157.5	23	N/A	25.4

MILKRITE REF.	OEM REF.	A (mm)	B (mm)	C (mm)	D (mm)
ALFA-LAVAL COMPATIBLE					
AL1U	960000-01	291	23.4	8	24
AL6U	999006-01	308	18.3	12.5	21.2
AL18U	960018-01	289	19.9	8	22.4
GOAT LINERS					
GGM97U	D381997	220	22	10	20
GDL513U	988513-01	153	21	N/A	20
GWS110U	7036-2725-110	300	22	9	2
JERSEY COMPATIBLE					
JERSEY	JERSEY	260	19.7	8.9	22.2
STRANGKO					
STRKO-1	3426010/10	300.5	22.3	10.6	20.9
BUFFALO					
BUFFALO		315	22.4	9.8	24



impulse® Product Range



MILKRITE REF.	A (mm)	B (mm)	C (mm)	D (mm)
IP10 U	312.5	22.5	9	57.9
IP10-01 U	287	22.5	9	58.5
IP11 U	287	20	13	58.5
IP12 U	302	22.5	8	58.5
IP13 U	303.5	22.5	12.5	58.5
IP14 U	152	22.5	N/A	58.5
IP15 U	320	22.5	10	58.5

MODELLO	UTILIZZO	GUAINA RIMPIAZZATE	PER COLLETTORE
IP10 U	Adatta a collettori con tubetto 12-13 mm, taglio dritto	FW15U, FW38U, FW68U, FW69U, GM22U, MS031U, MS197U, MS 897U, WS240U, WS270U	Fullwood (Freeway, Diamond), Manus (Optimum), GM (Isolac), Strangko, TDM
IP10-01 U	Adatta a collettori con tubetto 12-13 mm, taglio dritto. Versione più corta per vacche con mammelle più basse	O23U	
IP11 U	Adatta a collettori con tubetto 14-16 mm, taglio dritto. Versione con foro più stretto e lunghezza inferiore per vacche con capezzoli piccoli e sacca più bassa	SAC012U, SAC010U, SAC020U, SAC022U	SAC (Uniflow)
IP12 U	Adatta a collettori con tubetto 10-11 mm, taglio a taglio obliquo	DM916U, GM16U, GM2U, GM74U, GM75U, GM85U, GM86U, GM88U, GM89U, GM91U, GM93U, GM95U, FW14U, FW27U, FW37U, FW46U, FW67U, WS025U, WS029U, DL000U, DL001U, DL017U, DL017U-01, DL178U, DL179U, DL295U, DL295-U10, SAC007U	Dairymaster, Fullwood, GM, Westfalia, DL, SAC
IP13 U	Adatta ai collettori tipo Harmony DL	DL009U, DL007U, DL007U-01, DL008U, DL4007U, AL6U, DL036U, DL37U, DL037U-01	DL, Fullwood, GM, SAC
IP14 U	Tettarella corta, necessita di bicchierino (ART. M08AV004XZ), può essere usata su ogni tipo di collettore. Scegliere il corretto tubetto del latte	WS110U, WS120U, WS150U, WS220U, WS230U, WS270U-01, WS3-100U, WS3-110U, FW22U, MEL278U, MEL450U	Westfalia
IP15 U	Adatta a collettori con tubetto 12-13 mm, taglio a taglio obliquo	907595-01, 999999-02, 960033-03, 999295-10, 990666-01, 990888-01, GM85U, GM89U, GM86U, GM88U, GM93U, GM95U, GM91U, DK1X, R1EX, DKFM	Dairymaster, DL, Fullwood, Westfalia, GM. Boumatic

MILKRITE REF.	A (mm)
M10AV005XZ	IP10 SHELL - Cannello
M10AV013XZ	IP10 PLASTIC WEIGHT - Peso in plastica
M10AV006XZ	IP10 S/S WEIGHT - Peso in acciaio



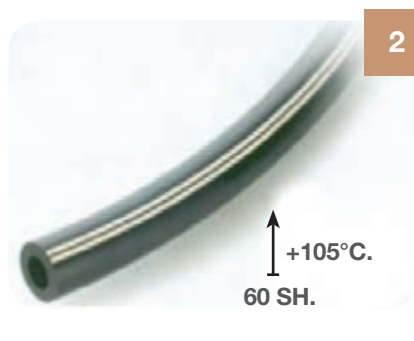

MILKRITE MILK TUBE (in rolls) – TUBO LATTE MILKRITE (in rotolo)

Art.	Ref.	Mm	Mt/roll
1	M14AV014CZ	8X16	MT.20
1	M14AV005CZ	13.5X23.8	MT.20
1	M14AV006CZ	13.5X24.7	MT.20
1	M14AV007CZ	14.5X25.5	MT.20
1	M14AV008CZ	15.5X27	MT.20
1	M14AV009CZ	16X27	MT.20
1	M14AV010CZ	19X31.8	MT.20
1	M14AV013CZ	20.5X35	MT.10
1	M14AV015CZT	22X35	MT.10
1	M14AV016CZT	28.6X44	MT. 3,660
1	M14AV017CZT	38X57	MT. 1,830

SPAGGIARI MILK TUBE – TUBO LATTE SPAGGIARI

Art.	Ref.	Mm	Mt/roll	Line
2	522EPB20	20x32	MT. 20	2 L. -BLUE
2	5022EP22	22x37	MT. 15	3 L. - ORANGE
2	5022EP29	29x46	MT. 15	BLACK
Art.	Ref.	Mm	Mt/roll	Line
3	10200221	7x14-7x14-14x25	MT. 20	GERMAN PRODUCTION
3	10200222	7x14-7x14-16x27	MT. 20	GERMAN PRODUCTION

RAL E-45
food quality



1



2

MILK TUBE GERMAN QUALITY – TUBO LATTE QUALITA' TEDESCA

Art.	Ref.	Ø	MT/ROLL	Line
1	10200217	6.3x13	25	1-ORANGE
1	10200211	8x16	25	1-BLUE
1	10200216	9X16	25	1-ORANGE
1	10200212	10x18	25	1-ORANGE
1	10200213	10x20	25	2-BLUE
1	10200219	12x22	25	2-BLUE
1	10200220	12x23	25	1 - GREEN
1	10200200	13x23	25	1-WHITE
1	10200201	14x24	25	1-WHITE
1	10200205	14x25	25	3-ORANGE
1	10200218	14,5x25,5	25	3-ORANGE
1	10200206	15x27	25	3 -GREEN
1	10200215	15.5x27	20	1-BLUE
1	10200207	16x27	25	1-BLUE
1	10200202	16x28	25	3 - ORANGE
1	10211202	16x28	25	3 - GREEN
1	10200210	18x30	25	3 - GREEN
1	10200208	19x32	25	3 - GREEN
1	10211208	19x32	25	1-BLUE
1	10200214	22x35	25	1-BLUE
1	10200209	24x38	25	1-ORANGE

SPRINGHOSE PVC TUBE FOR FOR ALIMENTARY LIQUIDS WITH STEEL SPIRAL (30 MT ROLL)

Art.	Ref.	Ø
2	30015009	12X18
2	30015019	25X33
2	30015014	30X38
2	30015005	32X40
2	30015017	35X44
2	30015004	38X47
2	30015003	40X49
2	30015015	51X61
2	30015021	60X72



1



2



3



4



5



6

Art.	Ref.	Ø
SILICONE TUBE (rolls of 25 mt) TUBO LATTE IN SILICONE BIANCO 60° SHORE (rotoli da 25 mt)- QUALITÀ AGROMILK		
1	10300040	5x8
1	10300050	6x12
1	10300060	7x10
1	10300070	7x12
1	10300080	7x14
1	10300085	7X14 BLUE
1	10311180	7,6X14,6
1	10300090	8x16
1	10300094	9x17
1	10200101	10x18
1	10300091	10x18 GREEN
1	10300095	12x21
1	10300122	12x22
1	10300100	13x23
1	10300101	14x24
1	10300086	14X24 GREEN
1	10312101	14x25
1	10300087	14X25 BLUE
1	10312102	14x26
1	10300102	16x25
1	10311102	16x26
1	10312103	16x27
1	10300088	16X27 GREEN
1	10312109	16x27 BLUE
1	10312110	16x27 BLUE 70° shore (DL)
1	10312104	16x28
1	10312111	16x28 GREEN
1	10312106	18x30

Art.	Ref.	Ø
1	10312105	19x29
1	10311105	20x30
1	10312107	20x32
1	10312108	20x34
1	10300089	20x34 BLUE
1	10300096	28x42
GREEN SILICONE TUBE - TUBO SILICONE VERDE, 70° SHORE, CORR. WF. 7021-7106-028		
2	00300545	16x26
2	00300547	16x28
SILICONE TUBE 60° SHORE TUBETTO SILICONE 60° SHORE		
	10300103	7,5x14x300
	10300104	7,5x14x370
	10300106	8x16x300
	10300107	8x16x270
	10300108	10x18x300
SILICONE TUBE, BLUE WITH 1 ORANGE LINE, 60° SH Tubo Silicone blu con 1 linea arancione 60° SH		
3	20160390	16X27, FITT. DL 90842380
3	20160391	14X25, FITT. DL 90842280
3	20160392	7.5X13 TWIN, FITT. DL 90846380
TWIN SILICONE TUBE (25 mt)		
4	10300010	7X14
4	10300015	7X14 BLUE
4	10300020	7,6X14,6
PVC TWIN TUBE		
5	522/0152	6,5x13+12,5x21 (mt. 30)
5	522/0151	7x14(x2)+14x23 (mt. 15)
SPRING S/S FOR TUBE REINFORCING Ø28		
6	2018-4993	

PVC HYBRID MILK HOSE – Tubo latte “HYBRID” in pvc



Made of a completely exclusive formulation of thermoplastic, elastomer compound, excellent for milk transfer. Very good alternative to silicon or rubber milk hose. Rolls of 25 mt

Properties:

Very Flexible 55 SH. Maximum resistance to clogs and kinks. Durability for long and reliable service. Hose and Material tested and approved for food contact according to European standard. FDA standard. UV- resistant. Phthalate Free approval
RoHS, Reach Standard EC food contact (EU) 10/2011 (MOCA)

Temperatures Range:

-40°C < Temp <80°C



Costituito da una formulazione completamente esclusiva di compound termoplastico, elastomerico, ottimo per il passaggio del latte. Rotoli da 25 mt. Ottima alternativa ai tubi in silicone o gomma. Proprietà: Molto flessibile 55 SH. Massima resistenza a ostruzioni e piegature. Duraturo e affidabile. Tubo e materiale testati e approvati per il contatto con gli alimenti secondo lo standard europeo. Norma FDA. Resistente ai raggi UV. Non contiene ftalati. Risponde alla normativa RoHS 10/2011 (MOCA). Utilizzabile in un intervallo di temperatura da -40°C a +80°C.

- HY-071400** 7x14 single
- HY-071422** 7x14 twin
- HY-142400** 14x24
- HY-162600** 16x26
- HY-193200** 19x32
- HY-223500** 22x35



“FLOWFLEX” MILK AND TWIN TUBE Tubo latte e tubo gemellare pvc “FLOWFLEX”

The FLOWFLEX tube distinguishes itself for its softness and flexibility that gets unchanged from -30° C to + 70° C.

Easy to fold, the FLOWFLEX tube excels in the resistance to knotting and to the overloading, if used in the limits of temperature and work recommended. The FLOWFLEX tube does not crack.

The inside surface, extremely smooth, ensures a total and quick cleaning. Light and smoothed, the FLOWFLEX tube can be handled with easiness. Packed in cardboard boxes and rolled in various lengths, it is comfortable and quick to store. For using it is only necessary to open the box, to suspend the roll and the tube is ready to be used.

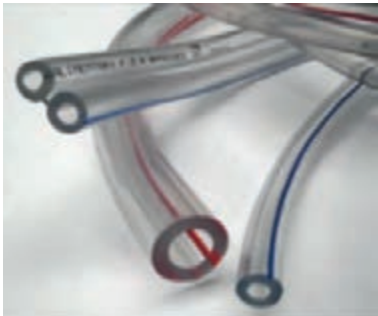

Il tubo FLOWFLEX si distingue per la sua morbidezza e flessibilità che si mantiene inalterata da -30° C a +70° C. Facile da piegare, il tubo FLOWFLEX eccelle nella resistenza all'annodatura ed al sovraccarico, se usato nei limiti di temperatura e di lavoro raccomandati.

Il tubo FLOWFLEX non crepa. La superficie interna, estremamente liscia, assicura una totale e veloce pulizia. Leggero e levigato, il tubo FLOWFLEX può essere maneggiato con facilità.

Imballato in scatole di cartone e arrotolato in varie lunghezze, è comodo e veloce da immagazzinare. Per l'uso occorre solo aprire la scatola, sospendere il rotolo ed il tubo è pronto per essere impiegato.



MILK TUBE

10451380	12,7x21 BLUE LINE	MT. 30
10451480	14x24 BLUE LINE	MT. 30
10451481	14x24 GREEN LINE	MT. 30
10451580	16x26 BLUE LINE	MT. 30
10451581	16x26 GREEN LINE	MT. 30
10451980	19x32 BLUE LINE	MT. 30
522/M025	25X37 (Spaggiari)	MT. 15
522/M030	30X43 (Spaggiari)	MT. 15

TWIN TUBE

10450781	7x14 - BLACK	MT. 50
10450881	7x14 - TRANSP. BLUE LINE	MT. 50
10450884	7x14 - TRANSP. GREEN LINE	MT. 50

10450981	7,6x14,6 - BLACK	MT. 50
10450982	7,6x14,6 - TRANSP. BLUE LINE	MT. 50
10450983	7,6x14,6 - TRANSP. GREEN LINE	MT. 50
10450992	9X19 - BLACK	MT. 30
10450993	9X19 - TRANSP.	MT. 50
10450950	9,5x15,9 - TRANSP.	MT. 30

SINGLE TUBE

10450780	7x14 - BLACK	MT. 50
10450880	7x14 - TRANSP. BLUE LINE	MT. 50
10450882	7,6x14,6 - BLACK	MT. 50
10450883	7,6x14,6 - TRANSP. BLUE LINE	MT. 50
10450980	9x19 - BLACK	MT. 50
10450990	9X19 - TRANSP.	MT. 50



EXTRUDED SHORT AIR TUBES, AGROMILK QUALITY
Tubetti aria trafilati, qualità AGROMILK

1	20090120	7x14x180
1	20090121	7x14x200
1	20090122	7x14x205
1	20090125	7x14x230
1	20090127	7x14x270
1	20090143	7x14x300
1	20090131	7,6x14,6x180
1	20090141	7,6x14,6x200
1	20090132	7,6x14,6x205
1	20090136	7,6x14,6x230
1	20090147	7,6x14,6x270
1	20090145 (Fitt. DM)	8x16x180 (blue line)
1	20090155	7,2x13,6x155 (orange line, German prod. - fitt. 90844282)

N.B. tubes 7x14 has blue stripe, 7.6x14.6 ones has red stripe

DIFFERENT COLOURED STRIPES ON DEMAND
 A richiesta si possono fornire tubetti con riga di diversi colori

REINFORCED AIR TUBES, DL STYLE
Tubetti aria rinforzati tipo DL

2	500BL580	L. 205, Ø 7.5
3	50000580	L. 205, Ø 7.5
3	50000581	L. 230, Ø 7.5
4	5243/039	Ø 6 L.230
5	5243/A39	Ø 6x13x230
5	500AR581	Ø 7,5x230
6	5243/049	Ø 6x13x230
6	500VE581	Ø 7,5x230

AIR TUBES, GERMAN PRODUCTION
Tubo aria produzione tedesca

7	10200203	SINGLE TUBE 7X13 (rolls of 25 mt.) TUBO SINGOLO 7X13 (rotolo 25 mt.)
		TWIN TUBE 7X13 (rolls of 25 mt.) TUBO GEMELLARE 7X13 (rotolo 25 mt.)
8	10200204	

AVON MILKRITE REINFORCED SHORT AIR TUBES - Tubetti aria AVON MILKRITE stampati

REF.	Mould ref.	Measure in mm	Pcs/Bag
M12AV017XZ	1031	4,8X10,8X203	20
M12AV018XZ	1027	6,4x12,4x165	20
M12AV019XZ	1028 (Fitt. 8506732)	6,4x12,4x190	20
M12AV020XZ	1030	6,4x12,4x229	20
M12AV021XZ	1033	7.1x14x190	20
M12AV022XZ	1034	7.1x14x229	20



1



2



3



4

AIR TUBES IN ROLLS, AGROMILK QUALITY Tubi aria in rotolo, qualità AGROMILK

ART.	REF.	DESCRIZIONE	MT/ROLL
1	20070500	TWIN (Gemellare) 7X14	(50 MT)
1	20070501	SINGLE (Singolo) 11X21	(35 MT)
1	20070502	SINGLE (Singolo) 7X14	(50 MT)
1	20070503	SINGLE (Singolo) 13X23	(35 MT)
1	20070504	TWIN (Gemellare) 7,6X14,6	(50 MT)
1	20070505	SINGLE (Singolo) 7,6X14,6	(50 MT)
1	20070506	SINGLE (Singolo) 8x16	(50 MT)

AVON MILKRITE AIR TUBE - Tubo aria avon MILKRITE

ART.	REF.	MEASURE IN MM	MT/ROLL
	M14AV019CZ	4X13	MT. 30
	M14AV018CZ	6X13	MT. 20
	M14AV002CZ	7X14	MT. 20
	M14AV003CZ	7X14 twin	MT. 20
	M14AV001CZ	8X16	MT. 20
	M14AV004CZ	8X16 twin	MT. 20
	M14AV011CZ	9.1X18	MT. 20
	M14AV012CZ	9.5X18	MT. 20
	M14AV020CZ	10X19	MT. 20

TUBE FOR ROBOT – Tubo per robot

ART.	REF.	DESCRIPTION	MEASURE
2	522/0700	Fitt. Lely in black Silicone	14X25 / 9X18, L. 70 cm
2	522/0701	Fitt. Lely in black Silicone	12X22 / 6.5X15 L. 101 cm
2	522/0702	Fitt. Lely in black Silicone	12X22 / 6.5X15 L. 119 cm
3	522/0603 (corr. DL 91701381)	Fitt. DL in black rubber	11.5X20X3.5 (central hose) (rolls of 25 mt)
2	522/0703	Fitt. Lely in black Silicone	12X22 / 6.5X15 L. 75 cm
2	522/0705	Fitt. Lely in rubber	12X22 / 6.5X15 L. (roll of 20 mt)
2	522/0706	Fitt. Lely in rubber	14X25 / 9x18 L. (roll of 20 mt)
4	50000720	Fitt. DL 90744903	10x18mm L. 172/178mm

MILK TUBES - TUBETTI LATTE

50000059

DL

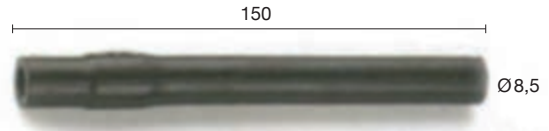

50000234

DL



50000042

DL



50000310

FULLWOOD



50000311

FULLWOOD



5000059W

WF - 7027-2637-100

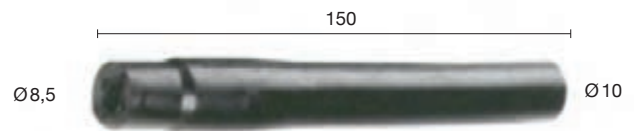

5000234W

WF - 7027-2637-110

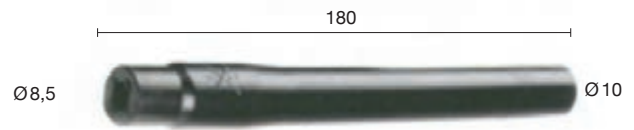

20095130

**WF - 7027-2637-080
7021-7101-000**



20095160

**WF - 7027-2637-090
7021-7101-010**



20095530

**WF - 7027-2637-100
7021-7101-020**



20095540

**WF - 7027-2637-190
7021-7101-030**



MILK TUBES - TUBETTI LATTE

20095640

WF - 7027-2637-110
7021-7101-090



50000586

WF - Ad. Meltec

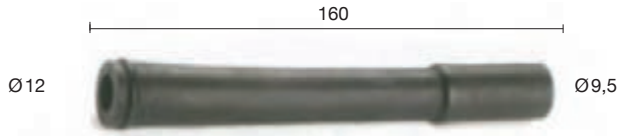

00300548

WF - 7021-7101-030



50000476

WF - 7027-2637-120
7021-7101-040

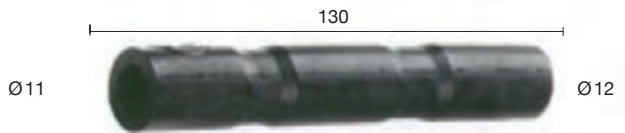

50000490

WF - 7027-2637-140
7021-7101-050

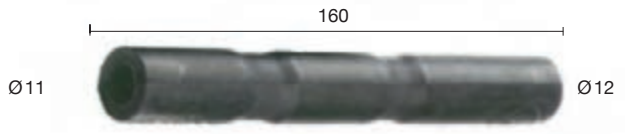

1900001
STARFISH HOSES GUIDE

Posizionatore a stella
(corr. FW 022408)



INTERPULS RETAINING RING - Anello fermatubi

1900060 Ø32
(corr. FW 022409)

1900059 Ø35
(corr. FW 022407)



1900049
RETAINER FLAT BAND Ø32

Fascetta stringitubo Ø32



88833351
HOSE HOLDER T. WF

Reggitubo T. WF
(corr. 7071-5467-060)



2019-0001 / 2019-0002
CLIPS WF STYLE

Reggitubo
tipo WF



2019-0001

2019-0002

1

2



00800108
SILICONE RING, DL ST.

Anello silicone tipo DL
CORR. 85231280



Articolo	REF.	DESCRIPTION	Ø
1	00300749	S/S RIGHT JUNCTION FOR TUBES Giunzione inox dritta per tubi	
2	522453SL	Anello - JOINT RING - RED SILICONE	31
2	50000453	Anello - JOINT RING	35
2	50000125	Anello - JOINT RING	28

AVON MILKRITE SHORT MILK TUBES - TUBETTI LATTE AVON MILKRITE

SMT 080 WS001	SMT 090 WS002	SMT 100 WS003	SMT 110 WS004
7027-2637-080	7027-2637-090	7027-2637-100	7027-2637-110
SMT 120 WS005	SMT 140 WS006	SMT 190 WS007	SMT 010 FW001
7027-2637-120	7027-2637-140	7027-2637-190	22010

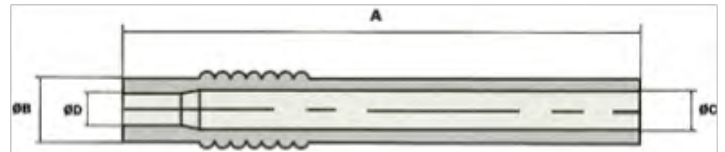

REF.	A	B	C	D	Suitable
SMT 080 WS001	140	20	10.25	8.5	WF 7021-7101-000 / 7027-2637-080
SMT 090 WS002	180	20	10.25	8.5	WF 7021-7101-010 / 7027-2637-090
SMT 100 WS003	140	20	10.25	10.25	WF 7021-7101-020 / 7027-2637-100
SMT 110 WS004	180	20	10	10	WF 7021-7101-090 / 7027-2637-110
SMT 120 WS005	130	21	11.5	10	WF 7021-7101-040 / 7027-2637-120
SMT 140 WS006	160	21	11.5	10	WF 7021-7101-050 / 7027-2637-140
SMT 190 WS007	160	20	10	10	WF 7021-7101-030 / 7027-2637-190
SMT 010 FW001	150	16.5	8.7	8.7	Fullwood 022010
SMT 013 FW002	155	20.2	11.2	11.2	Fullwood 022013

EXTRUDED BENDED MILK TUBES FITTING DL

Tubi latte curvati estrusi adattabili DL

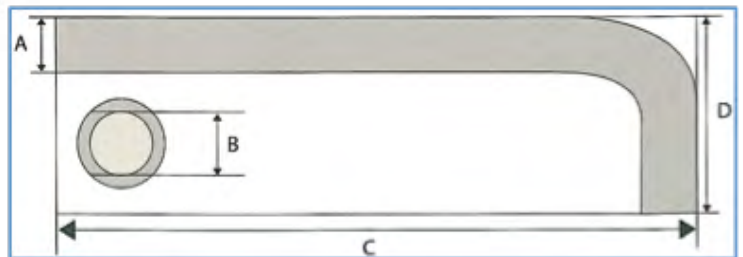

REF.	A	B	C	D	Suitable
M04DL001XZ	27.7	14	800	80	969474-01
M04DL002XZ	24.7	14	1000	70	999588-01
M04DL003XZ	26.9	16	800	80	998382-01
M04DL004XZ	34.5	20	500	97	967458-01



PLASTIC CLIP FOR TUBING Stringitubo plastica

ART.	REF.	DESCRIZIONE/Ø
1	00100618	MILK-TWIN TUBE Tubo latte/gemellare
2	00100523	MILK-TWIN TUBE Tubo latte/ gemellare
3	00100619	SINGLE TUBE Tubo latte/singolo
4	00100548	SCISSORS FOR HOSE CUTTING Forbici per taglio tubi gomma
4	00111548	BLADE FOR 00100548 (SPARE PART) Lama di ricambio per 00100548
5	00494900	PLASTIC SCISSORS, ECONOMIC TYPE Forbice plastica tipo economico
6	00100006	TOOL FOR MOUNTING LINERS Attrezzo montaggio guaine

CLEAR FITTINGS (MILK & FOOD APPROVED) Raccordi trasparenti alimentari

7	00300520	Ø 4 est.
7	00300521	Ø 6 est.
7	00100217	Ø 8 est.
7	00100218	Ø 10 est.
7	00100219	Ø 12 est.
7	00100220	Ø 14 est.
7	00100221	Ø 16 est.
8	00300522	Ø 4 est.
8	00300523	Ø 6 est.
8	00100222	Ø 8 est.
8	00100223	Ø 10 est.
8	00100224	Ø 12 est.
8	00100225	Ø 14 est.

8	00100226	Ø 16 est.
9	00300524	Ø 4 est.
9	00300525	Ø 6 est.
9	00100227	Ø 8 est.
9	00100228	Ø 10 est.
9	00100229	Ø 12 est.
9	00100230	Ø 14 est.
9	00100231	Ø 16 est.
10	00300526	Ø 4 est.
10	00300527	Ø 6 est.
10	00100232	Ø 8 est.
10	00100233	Ø 10 est.
10	00100234	Ø 12 est.
10	00100235	Ø 14 est.
10	00100236	Ø 16 est.

3 WAYS STRAIGHT / A 3 vie

11	00300528	Ø 4/5/6 est.
11	00300529	Ø 6/7/8 est.
11	00100237	Ø 8/9/10 est.
11	00100238	Ø 10/11/12 est.
11	00100239	Ø 12/13/14 est.
11	00100240	Ø 14/15/16 est.

STRAIGHT / Rettilineo

12	00300534	Ø 4/5/6 est.
12	00300535	Ø 6/7/8 est.
12	00100241	Ø 8/9/10 est.
12	00100242	Ø 10/11/12 est.
12	00100243	Ø 12/13/14 est.
12	00100244	Ø 14/15/16 est.



FOR DIFFERENT Ø
Per ø diversi

ART.	REF.	DESCRIZIONE/Ø
13	00100245	Ø 4-6-8/8-10-12
13	00100246	Ø 4-6-8/12-14-16
13	00100247	Ø 8-10-12/12-14-16

MILK PLASTIC VALVE
Rubinetto latte plastica per usi diversi

14	00100202	Ø 40-38 - 2 WAYS
14	00100203	Ø 52-51 - 2 WAYS
14	00100204	Ø 63-53 - 2 WAYS
14	00100205	Ø 76-64 - 2 WAYS
15	00100206	Ø 40-38 - 3 WAYS
15	00100207	Ø 52-51 - 3 WAYS
15	00100208	Ø 63-53 - 3 WAYS
15	00100209	Ø 76-64 - 3 WAYS

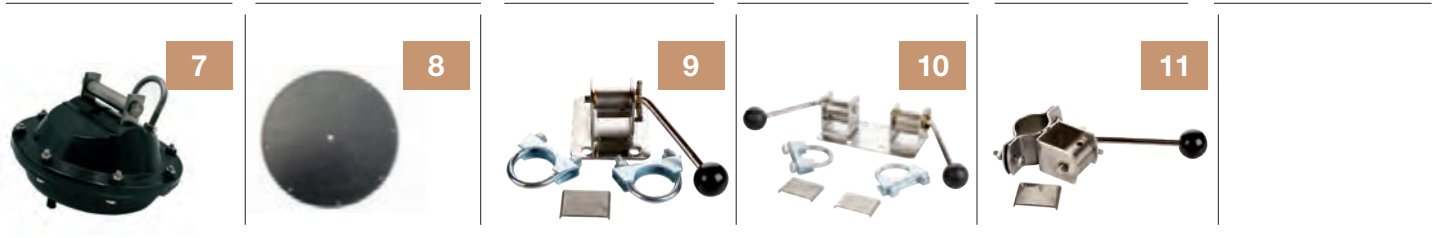
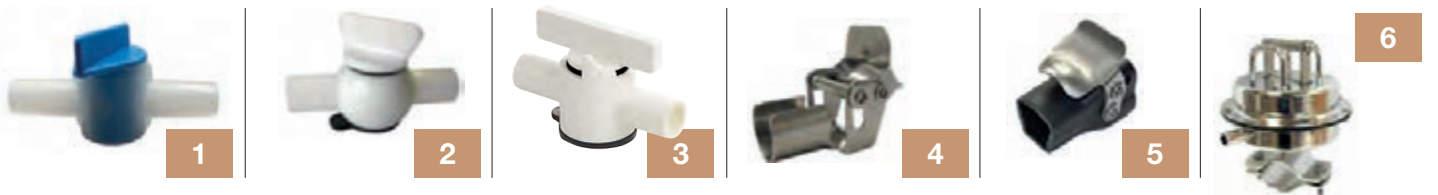

ART.	REF.	DESCRIZIONE/MEASURE
INTERCEPTING VALVES (PLASTIC) Rubinetti di intercettazione in plastica		
1	00100212	Ø 16 est.
1	00100213	Ø 14 est.
1	00100214	Ø 10 est.
1	00100215	Ø 8 est.
2	20070123	Ø 19 EST. PLASTIC - NO HOLE
2	20070151	Ø 19 EST. - WITH HOLE
2	20070152	Ø 22 EST. PLASTIC - NO HOLE
2	20070153	Ø 22 EST. - WITH HOLE
2	20070132	TAB GASKET FOR Ø 19
2	20070133	LOWER O'R FOR Ø 19
2	20070134/20070154	LOWER/UPPER O'R Ø 22
3	20070135	Ø 19 ECONOMIC TYPE - NO HOLE

S/S PINCH CLAMP – pinza inox

4	00100079	T. Ø12 I. Ø23 O.
---	----------	------------------

4	00100080	T. Ø16 I. Ø27 O.
---	----------	------------------

PLASTIC PINCH CLAMP – pinza plastica

5	00300144	T. Ø12 I. Ø23 O.
5	00300145	T. Ø16 I. Ø27 O.

VACUUM PINCH CLAMP
Valvola stringitubo pneumatica

6	00100841	STAINLESS STEEL - Acciaio
7	00100532	PLASTIC - Plastica

8	00100842	DIAPHRAGM FOR 00100841 Membrana per 00100841
---	----------	--

8	00111532	DIAPHRAGM FOR 00100532 Membrana con 00100532
---	----------	--

S/s pinch for 14x25 and 16x28
Pinza inox per 14x25 e 16x28

9	00600147	ON PLATE - su piattina
10	00600148	DOUBLE ON PLATE - doppia su piattina
11	00600149	ON FLANGE Ø 51 - su morsetto ø 51

CLAWS – COLLETTORI

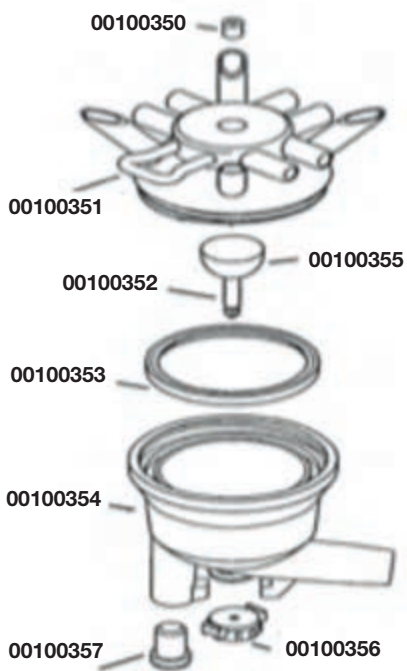

Ø 12,5



00100349
S/S CLAW DL TYPE 160 CC
 Collettore inox 160 cc. filetto DL
 (corr. 99670090)



00100378
COMPLETE BOWL
 Coppetta completa
 Corr. 99670081

00100379
SIMPLE BOWL
 Coppetta nuda
 Corr. 99670084
 (99547303+98588701)

PLASTIC CLAW MS TYPE 90 CC. – COLLETTORE PLASTICA TIPO MS 90 CC.

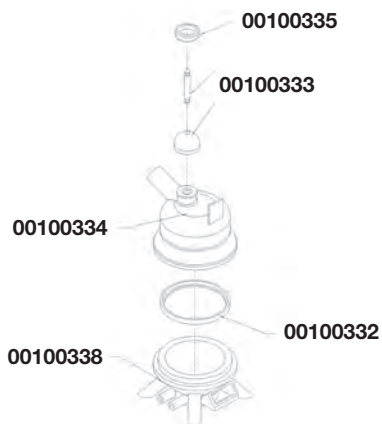

Ø 14



00100331
PLASTIC CLAW MS TYPE 90 CC.
 Collettore plastica tipo MS 90 cc.



00100530
COMPLETE BOWL FOR 00100331
 Coppetta completa per collettore
 00100331

PLASTIC CLAW DL TYPE 90 CC. - COLLETTORE PLASTICA TIPO DL 90 CC

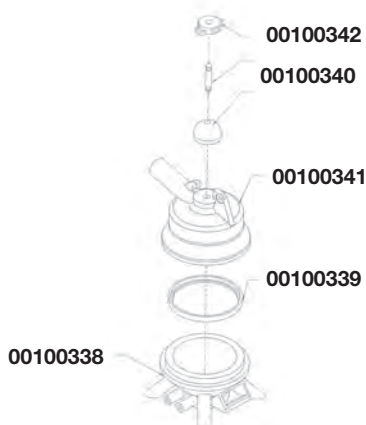

Ø 14



00100337
PLASTIC CLAW DL TYPE 90 CC.
 Collettore plastica tipo DL 90 cc



00100531
COMPLETE BOWL FOR 00100337
 Coppetta completa per collettore
 00100337



00300300
PLASTIC CLAW DL
THREAD
 Collettore plastica
 Filetto DL



20090070
PLASTIC
CLAW DL
THREAD
 Collettore plastica
 Filetto DL
 Corr. 960203-80

Ø 14

Ø 14

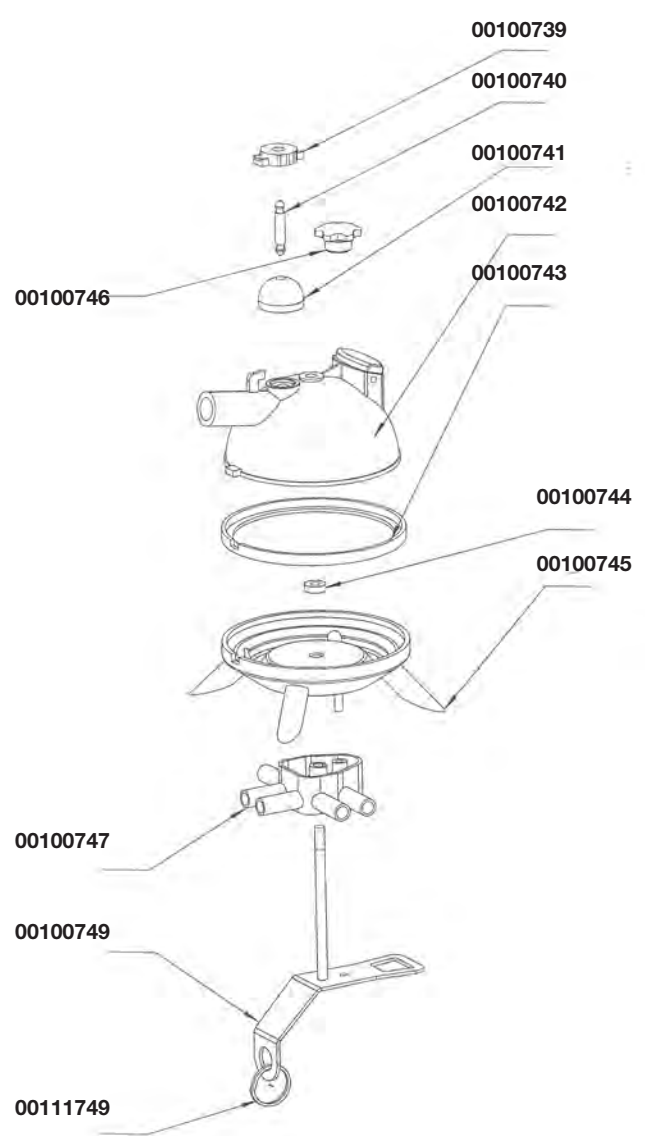

00100738
COLLETTORE
250 CC
 Con corpo in plastica

Ø 13,5

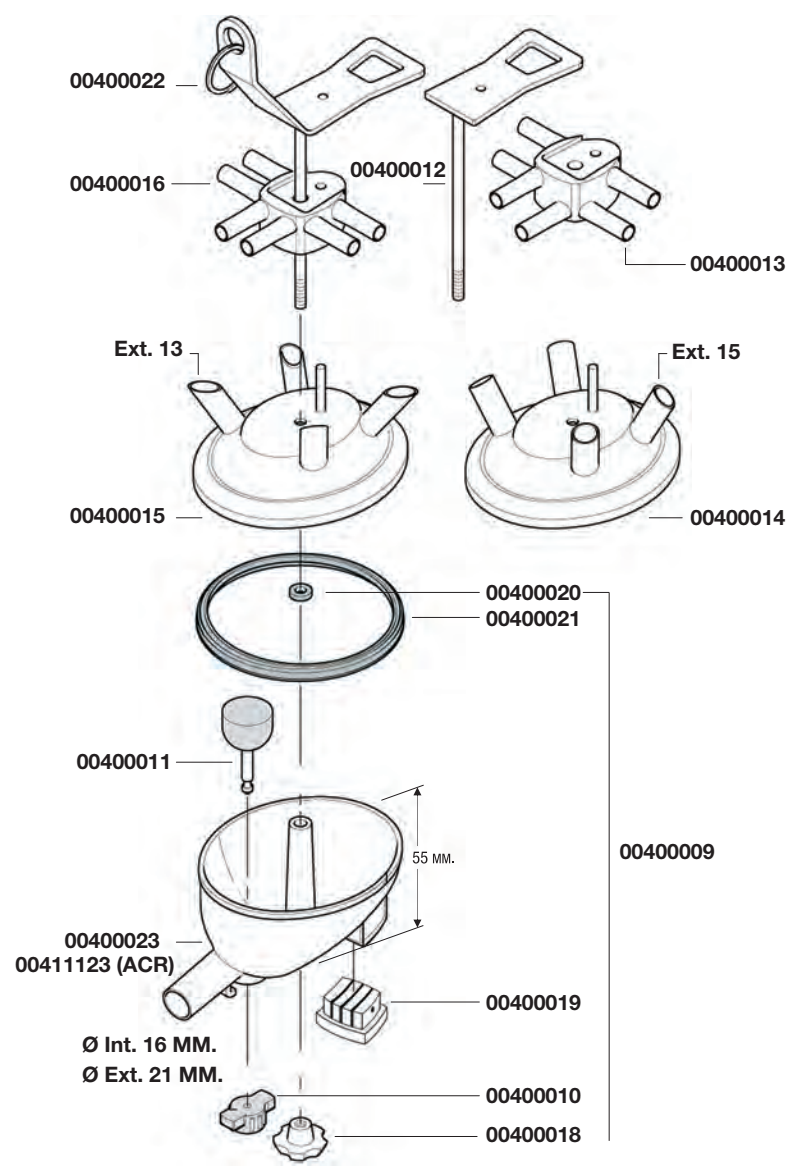

Ø Ext. 13 MM.

00400004
CLAW FITT. ITP 350 CC
- 13 MM
 Collettore adatt. ITP 350 CC
 - 13 MM



Ø Int. 16 MM.
 Ø Ext. 21 MM.

- 00400005** - 13 MM / ACR
- 00400006** - 15 MM
- 00400007** - 15 MM / ACR

SPARE PARTS FOR FULLWOOD CLEARFLOW RICAMBI PER COLLETTORE FULLWOOD CLEARFLOW



Art.	Ø
1. 00709800	SHUT-OFF Valvola con perno (corr. 021501)
2. 00709900	M5 PIVOT NUT Dado M5 (corr. 021633)
3. 00710100	LOCK-OPEN CAP Cappuccio (corr. 021502)
4. 00710200	OPERATING PLUNGER S/ASSY Pistone (corr. 021514)
5. 00710300	PIVOT NUT CAP Cappuccio dado (corr. 021533)
6. 00710400	M6 NYLON WASHER 110D 0.7T Rondella Nylon (corr. 021644)
7. 00710500	RETAINING "R" CLIP Clip (corr. 002933)
00710900	GASKET / Guarnizione (corr. 021740)

ART.	REF.	DES.
9	00300607	BOWL FITT. FULLWOOD REF. 021748 (w/o shut-off) Coppetta tipo fullwood 021748 (senza valvola)
8	00300608	BOWL FITT. FULLWOOD REF. 021742 (for shut-off) Coppetta tipo fullwood 021742 (per valvola)



S/S BRACKET FOR MILKING CLUSTER SUPPORTO GRUPPO MUNGITORE IN ACCIAIO INOX

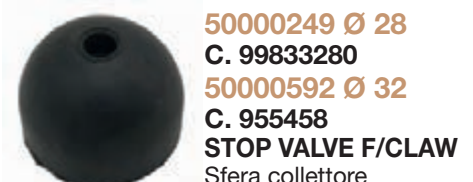

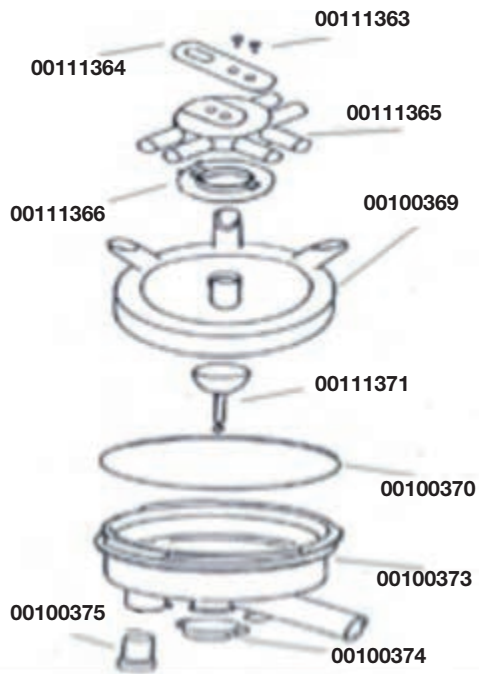

00100367
S/S CLAW 400 CC. LIGHT TYPE
 Collettore Inox 400 cc.
 Tipo leggero

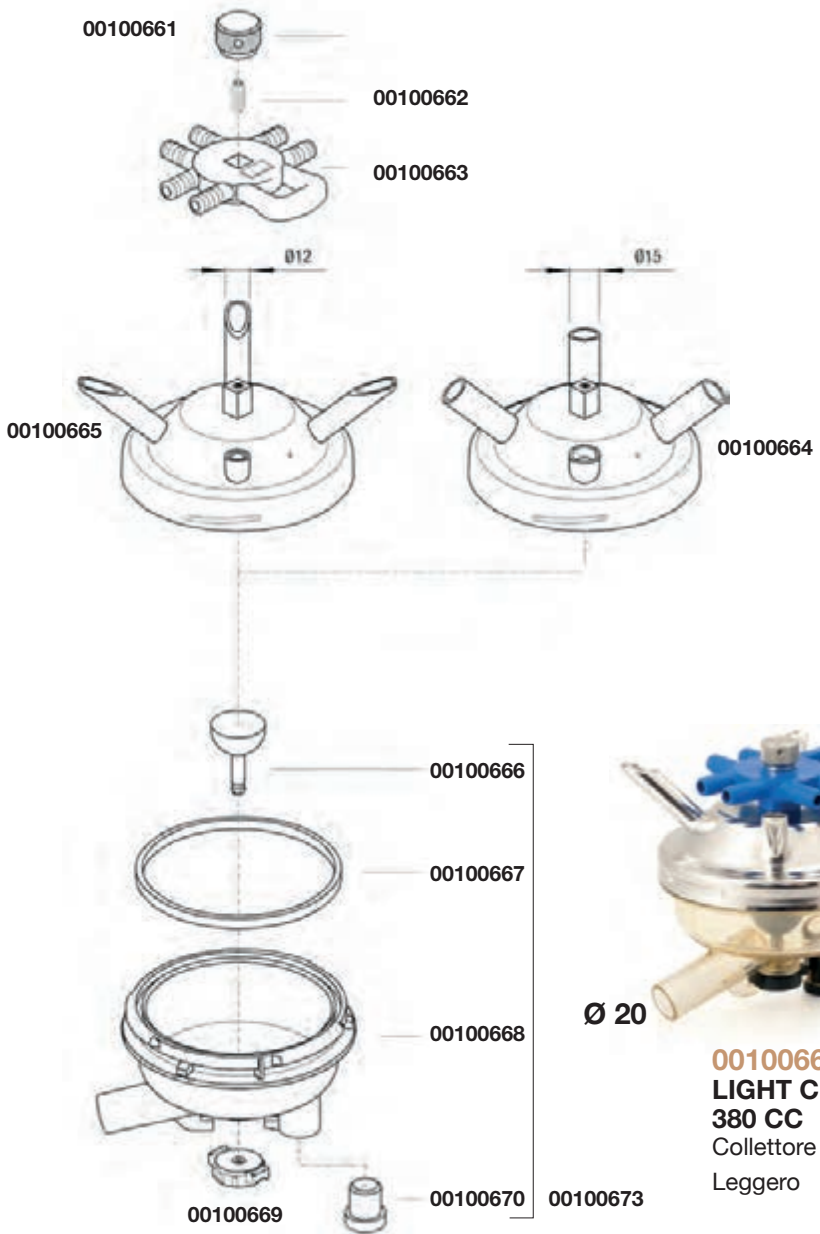

00100660
LIGHT CLAW
380 CC
 Collettore 380 cc
 Leggero



00111357
CLAW/COLLETORE
 "TRILINER" 380 CC.

The spare parts are like the ones of claw 00100660. The only difference is the s/s body, which reference is 00100664

I ricambi corrispondono a quelli del collettore 00100660. L'unica differenza riguarda la base in acciaio inox, il cui riferimento è 00100664



00401431
CLAW BOWL
 FITT. FREEWAY
 (PACKO-FULLWOOD)
 Corr. 215036 PACKO

Coppetta adattabile collettore Freeway (Packo-Fullwood)



00401432
CLAW BOWL
 FITT. FREEWAY
 (PACKO-FULLWOOD)
 WITH STRAIGHT
 INLETS
 Corr. 215035 PACKO

Coppetta adattabile collettore Freeway (Packo-Fullwood) con uscite dritte



00401438
GASKET FOR
FREEWAY CLAW
 Guarnizione collettore Freeway
 Fitt. ref. 47282

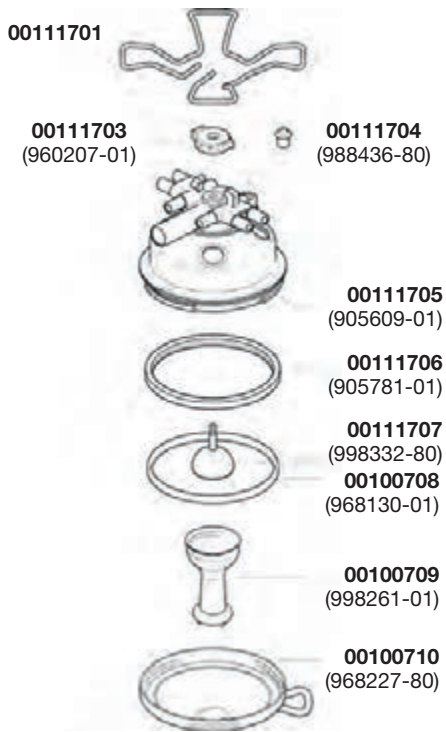

00111700
CLAW/collettore tipo
HRMNY TF 360
20080705
COMPLETE BOWL
FOR 00111700
 Coppetta completa
 per 00111700

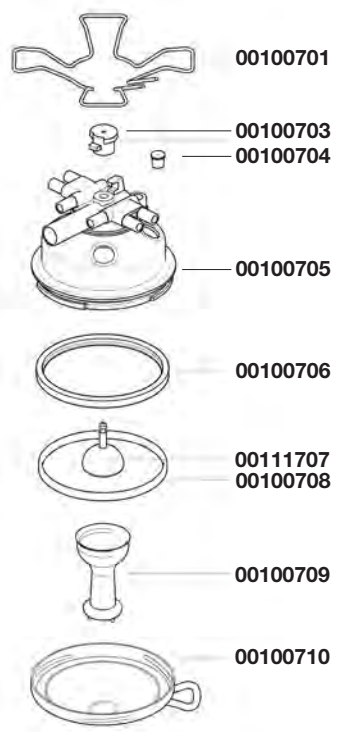

00100700
CLAW/collettore tipo
HRMNY TF 350



20090250
HRMNY CLAW STYLE
FOR ACR
 Collettore tipo HRMNY per
 stacco automatico



00100799 TF 360
S/S BRACKETS FOR DL
CLAWS
 Supporti inox per collettore DL



00100711
S/S BRACKET FOR HRMY
CLAW
 Supporto inox per collettore HRMY



00300729
S/S BRACKET
FOR HRMY CLAW
 Supporto inox per gruppo HRMY

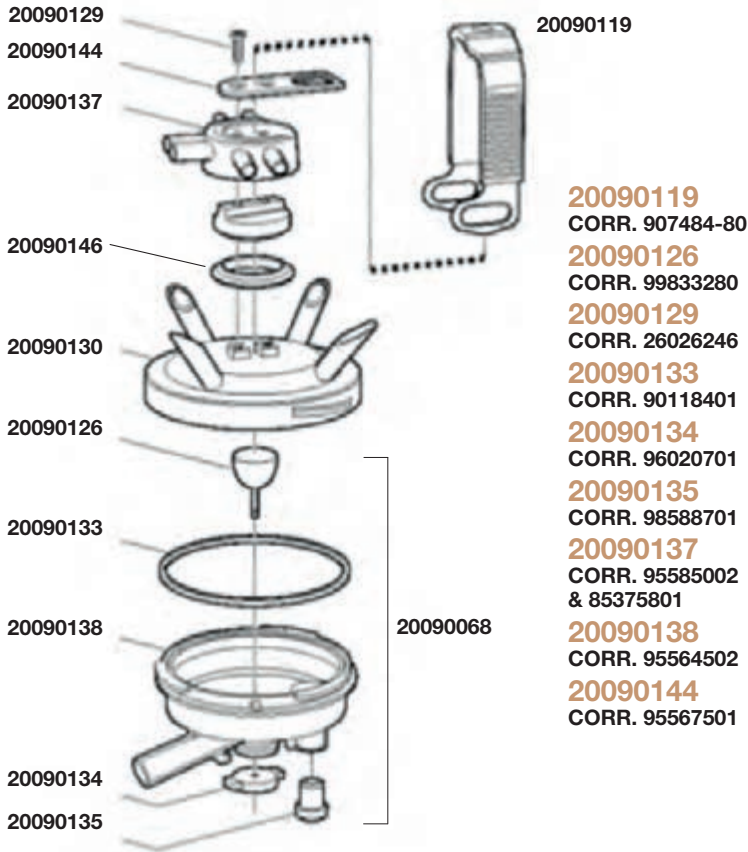

20090119
20090119
CORR. 907484-80
20090126
CORR. 99833280
20090129
CORR. 26026246
20090133
CORR. 90118401
20090134
CORR. 96020701
20090135
CORR. 98588701
20090137
CORR. 95585002 & 85375801
20090138
CORR. 95564502
20090144
CORR. 95567501



20090068
COMPLETE BOWL
FOR 20090059
 Coppetta completa per 20090059

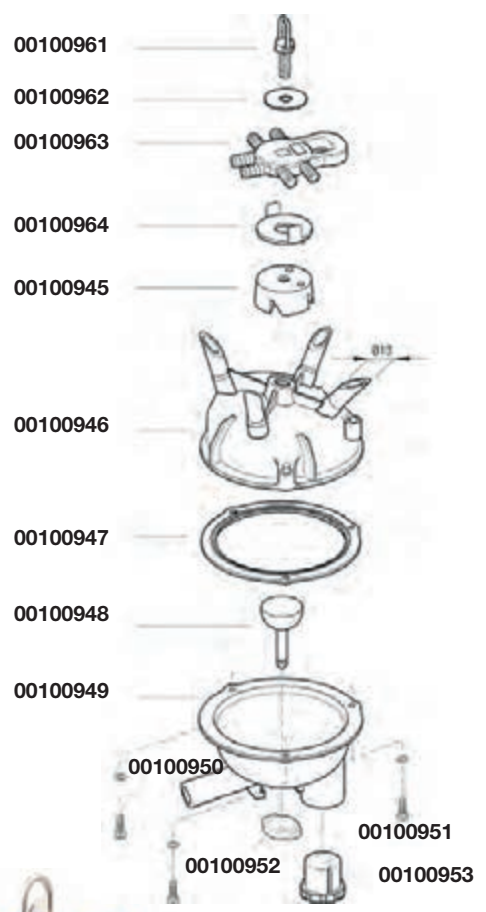

00100961
00100962
00100963
00100964
00100945
00100946
00100947
00100948
00100949
00100950
00100951
00100952
00100953



00100960
MINI-ORBIT CLAW
SURGE TYPE WITH
EUROPEAN HOOK
 Collettore mini-orbit surge con gancio europeo

“CALIFORNIA BOWL” Coppetta California



00100380
COMPLETE
 Completa
00100381
SIMPLE
 Nuda



20090059
MC3 CLAW
WITH VALVE
 Collettore MC3 con valvola



00100513
200 CC BOWL WITH DL
THREAD
 Coppetta 200 cc filetto DL
50000216
GASKET FOR/Guarnizione per
 00100513

00100514
S/S JET FOR BACK FLUSH
 Ugello inox per sanizzante



20070125
COMPLETE BOWL 400
CC, MS TYPE
 Coppetta completa 400 cc, tipo MS

S/S CLAW 300 CC. WF TYPE "CLASSIC 300" - COLLETTORE INOX 300 CC. TIPO WF "CLASSIC 300"

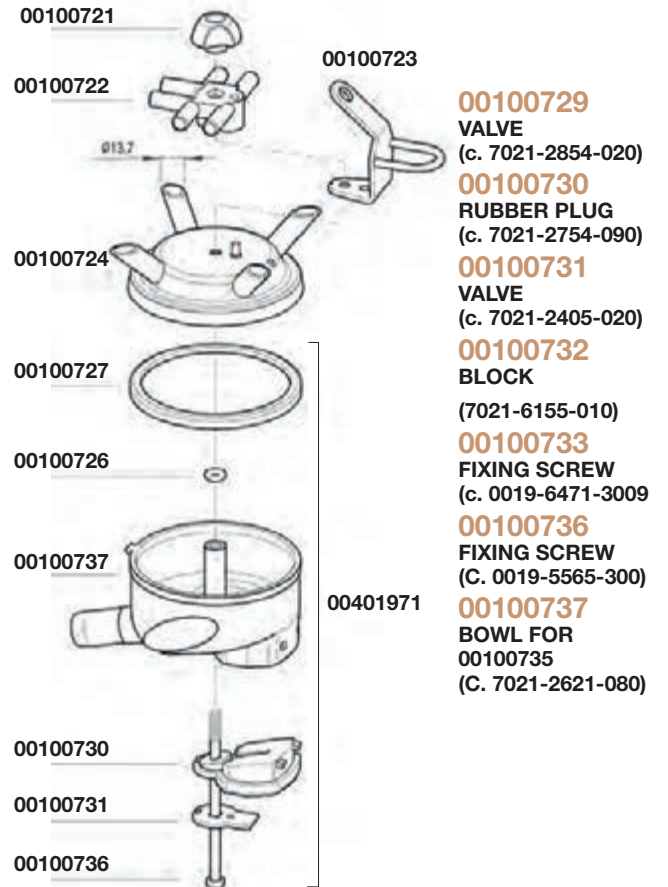
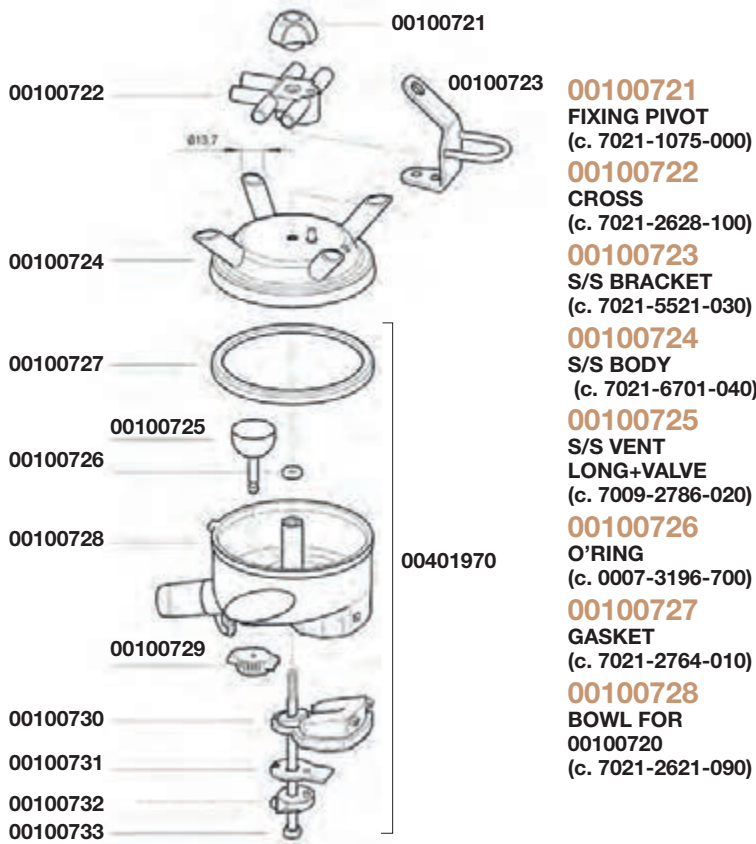

00100720
WITH VALVE
 Con valvola
 (c. 7021-2620-300)



00100735
WITHOUT VALVE
 Senza valvola
 (c.7021-2620-290)



00401975
WITH (CON) SHUT/OFF

00401976
WITHOUT (SENZA) SHUT/OFF

00401974
S/S CLAW BASE ONLY
 Base collettore in acciaio

WF STYLE CLAW, (SO CALLED "EVOLUTION") WITH REAR AND FRONT NIPPLES IN DIFFERENT POSITIONS

Collettore tipo WF (cosiddetto "EVOLUTION") con nipples anteriori e posteriori in posizioni differenti



00300247
TRANSP. BODY FOR STRANGKO CLAW
 Cilindro trasparente x coll. STRANGKO
 Corr. 603001730

00300248
GASKET FOR STRANGKO CLAW
 Guarnizione x coll. STRANGKO
 Corr. 603001731

ART.	REF.	DES.
1	20070124	COMPLETE BOWL FOR WF 200 CC CLAW Coppetta completa per collettore wf 200 cc (corr. 7021-2447-010)
1	20090055	BOWL ONLY - Coppetta nuda
1	20090056	GASKET - Guarnizione Corr. 7021-2764-000
1	20090057	SHUT-OFF VALVE - Valvola c/perno
1	20090058	BUTTERFLY VALVE Valvola a farfalla (corr. 7021-2854-020)
1	20090251	DAMPER - Ammortizzatore Corr. 7021-2754-080
2	00111378	COMPLETE BOWL WF THREAD NEW TYPE Coppetta completa filetto wf tipo nuovo
2	20090045	BOWL ONLY - Solo coppetta
2	20090046	GASKET - Guarnizione
2	20090047	SHUT-OFF VALVE - Valvola c/perno
2	20090048	BUTTERFLY VALVE - Valvola a farfalla
3	0300605	FLO-TEK BOWL COMPLETE (MK2) Coppetta completa flo-tek (mk2) DL TYPE 230 CC - tipo DL 230 CC
3	0300606	FLO-TEK BOWL COMPLETE (MK2) Coppetta completa flo-tek (mk2) WF TYPE 230 CC - tipo WF 230 CC
4	00300154	MIELE BOWL - Coppetta MIELE Corr. 7720-1845-110
4	00311154	GASKET (Guarnizione) FOR 00300154
5	00300151	DAIRYMASTER BOWL FOR SHUT-OFF VALVE Coppetta dairymaster per valvola shut-off CORR. SF 201
5	00300604	MAIN GASKET ONLY Guarnizione principale
6	00300035	MAINTAIN KIT FOR MILK CLAW FOR DAIRYMASTER CORR. SF203 (10320349)
7	00300036	MAINTAIN KIT FOR MILK CLAW (W/O VALVE) Corr. SF309 (10320281)
8	00100761	CENO" CLAW 400 CC. FRONT/REAR MILKING Collettore "ceno" 400 cc. mungitura front/rear
9	00300615	DAIRYMASTER BOWL W/O SHUT-OFF VALVE Coppetta dairymaster senza valvola shut-off CORR. SF 212 (10320166)
10	00767600	GASKET FOR DL HARMONY PLUS - Guarnizione tipo DL per HARMONY PLUS - Corr. 90539101
11	00762700	PLUG FOR HARMONY PLUS Tappo HARMONY PLUS - (Corr. 92504501)
12	00100074	RUBBER ARMED PLUG FOR DL - MS WITH TEAR - Tappetto con taglio
13	00100075	RUBBER ARMED PLUG FOR DL MS WITHOUT TEAR - Tappetto senza taglio

00800131
BOWL FOR HARMONY PLUS
 Coppetta tipo HARMONY PLUS
 Corr. 90531502



SPARE PARTS FOR FLO-STAR BOUMATIC CLAW - ricambi per collettori FLO-STAR BOUMATIC



Art.	Descr.
00439100	STD FLO STAR CLAW W/VALVE (5/8") VENTED Collettore FLO STAR STD c/valvola (5/8") (ventilato)
00439300	CLASSIC FLO STAR CLAW W/VALVE (5/8") VENTED Collettore FLO STAR CLASSIC c/valvola (5/8") (ventilato)
00442500	WHITE CLAW BASE FOR FLO STAR W/VALVE HOLE Base bianca per FLO STAR con valvola



Art.	Descr.
00439200	STD FLO STAR CLAW W/O VALVE (5/8") VENTED Collettore FLO STAR STD senza valvola (5/8") (ventilato)
00439400	CLASSIC FLO STAR CLAW W/VALVE (5/8") VENTED - Collettore FLO STAR CLASSIC senza valvola (5/8") (ventilato)
00442600	WHITE CLAW BASE FOR FLO STAR W/O VALVE HOLE - Base bianca per FLOSTAR senza valvola

STANDARD (OLD MODEL)

1



CLASSIC (NEW MODEL)

2



FLO-STAR STANDARD (the bowl is 2-7/8" high and has a round gasket) FLO-STAR STANDARD

(la coppetta è alta 2-7/8" e ha una guarnizione rotonda)

Art.	Ref.	Descr.
1A.	00300050	CLAW BOWL NON VENTED (8510909) Coppetta non ventilata
1B.	00300051	CLAW BOWL VENTED - Coppetta ventilata
4D.	00300052	BOWL GASKET (8506681) Guarnizione coppetta
3P.	00300212	START LOCK WASHER - Rondella a stella
3Q.	00300213	SILICONE O'RING FOR BUMPER O'ring silicone
4E.	00300053	SMALL ROUND SEAL (8513528) Guarnizione di tenuta rotonda, piccola
4F.	00300054	LARGE ROUND SEAL (8506817) Guarnizione di tenuta rotonda, larga
4G.	00300055	SPRING (8506693) - Molla
4H.	00300056	SHUT-OFF VALVE (8506899) Valvola con perno
4I.	00300057	LOCK (8506668) - Fermo
4J.	00300058	SLEEVE FOR SHUT OFF (8506920) Manicotto per valvola con perno
4K.	00300059	VALVE HANDLE (8506669) - Maniglia valvola
4L.	00300060	NUT - Dado
4M.	00300061	WASHER - Rondella

3

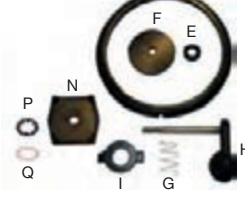

4



5



6

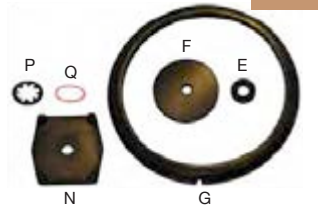

FLO-STAR CLASSIC (the bowl is 2-1/4" high and has a squared gasket) FLO-STAR CLASSIC

(la coppetta è alta 2-1/4" e ha una guarnizione squadrata)

Art.	Ref.	Descr.
2A.	00100939 OLD T.	CLAW BOWL VENTED Coppetta ventilata
2B.	00300066	CLAW BOWL VENTED - Coppetta ventilata
3N.	00300065	LARGE SQUARE SEAL (8515625) Guarnizione di tenuta squadrata, larga
3	00300062	RUBBER KIT (WITH VALVE) THIS KIT WORKS ON STANDARD AND CLASSIC CLAWS WITH A SHUT OFF VALVE - KIT GOMMA (con valvola) Questo kit è adattabile sui collettori Classic e Standard dotati di valvola con perno
5	00300063 ft. 8506724	VALVE KIT - Kit valvola
6	00300064 ft. 8506723	RUBBER KIT (NO VALVE) THIS KIT WORKS ON STANDARD AND CLASSIC CLAWS WITHOUT A SHUT OFF VALVE - KIT GOMMA (senza valvola). Questo kit è adattabile sui collettori Classic e Standard senza valvola con perno
7	00442700	S/S AIR FORK (Forcella inox) fitt. 8511191

FREE-FLOW CLAW (FOR AFIMILK PARLOURS)



00300071

The new FREE – FLOW cluster (450 CC) is designed to handle cows with asymmetric teats as well as “classic teats”. It is possible thanks to the four different positions of the cluster’s milk inlets. The customer can select it according to the parlor type.

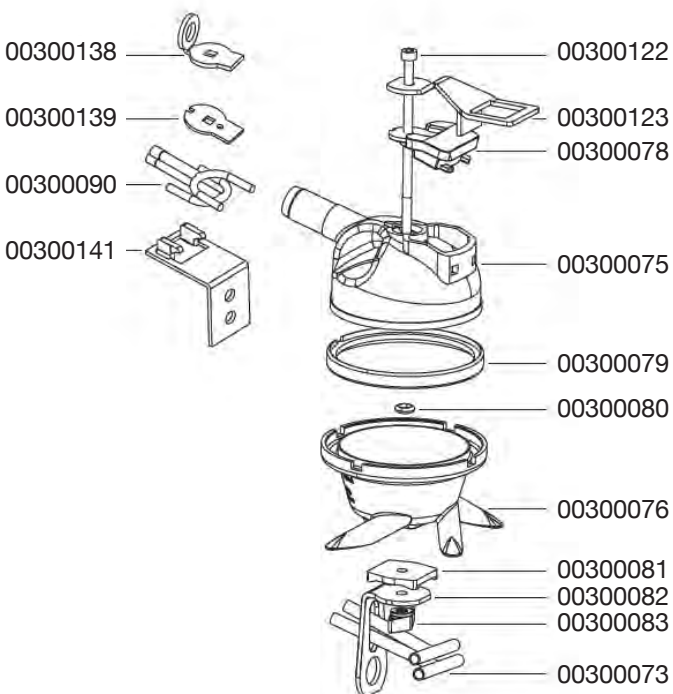

VISI-CLAW



00300183

The VISI-CLAW CLUSTER (450 CC) was designed in search of a solution for milking cows in a parallel or a rotating parlor, where the cows must be milked from behind. This claw can also be used in a herring bone parlor.

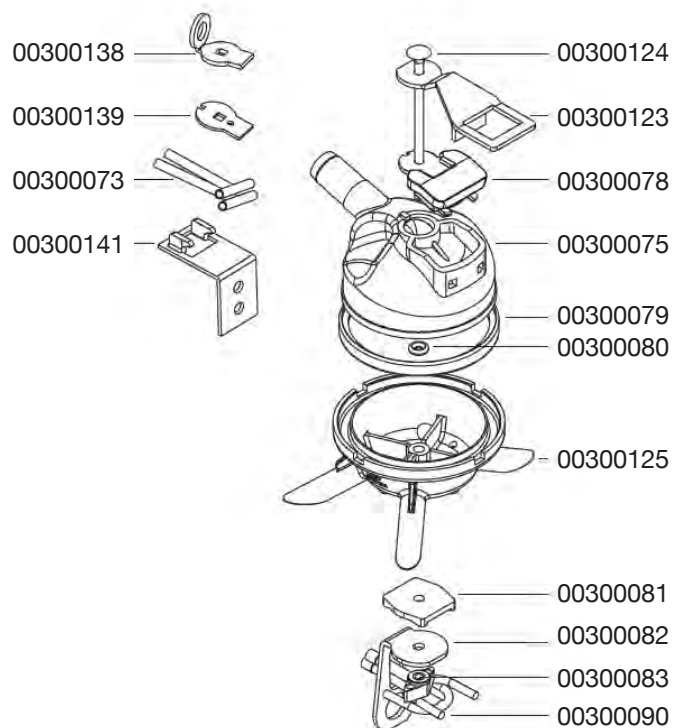

SAC CLAW SPARES – Ricambi collettori Sac

00800901
KIT FOR UNIFLOW2
 (outside and central
 gaskets
 corr. 25200110
 + 25200113)



00800902
S/S HOOK FOR
UNIFLOW 3,
 corr. 21200143



00800903
KIT FOR UNIFLOW3
 (outside and central
 gaskets
 corr. 25100197
 + 25100193)



00800904
S/S FLEXIBLE HOOK
FOR UNIFLOW3
 Gancio inox flessibile
 per uniflow 3



00800134
BOLT PLASTIC WITH EYE FOR
UNIFLOW
 Gancio in plastica con
 occhiello per UNIFLOW
 CORR. SAC. 212.00.143



00800309
PLASTIC COVER FOR
UF2 SAC CLAW
 Coppetta plastica per
 collettore UF2 SAC



INTERPULS CLAWS

1579003
LUNIK 200 CLAW
 Collettore Lunik 200



1539249
ORB350 HD WITH
VALVE-45°-13X10

1539252
ORB350 HD WITHOUT
VALVE-45°-13X10 F/R

1539254
ORB350 HD WITHOUT
VALVE 45°-13X10 B/F

